

# THESIS

Technology Art + Sound  
Manufactured by  
**elettromeia** Italy

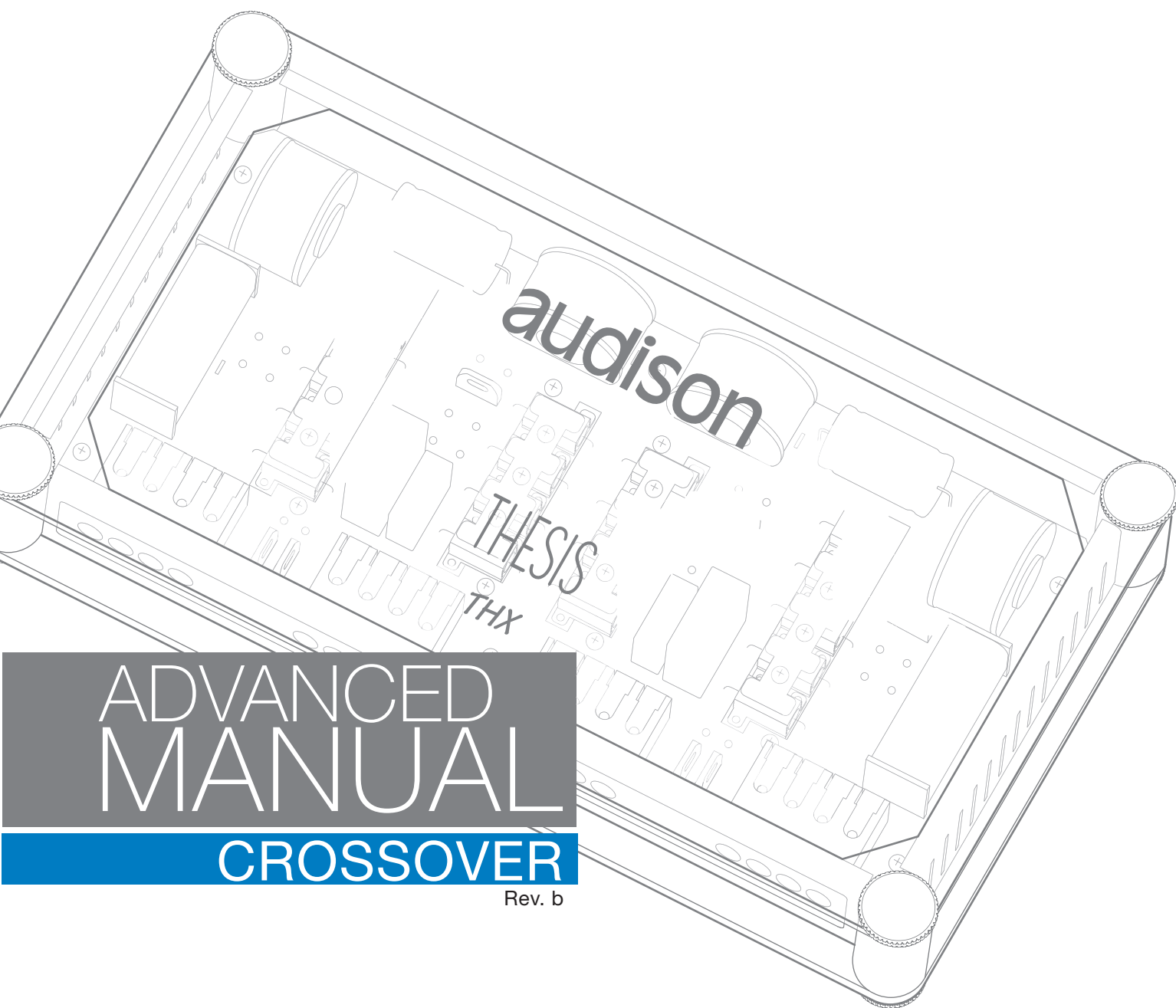

ideato,  
progettato,  
costruito  
in Italia



ADVANCED  
MANUAL

CROSSOVER

Rev. b

**audison**  
[www.audison.eu](http://www.audison.eu)



# Index

	02
THESIS - The project	03
Assembling and Cable connection	04
Size	05
<b>THX 2</b>	
THX 2 Mono-Wiring connections	07
THX 2 Bi-Wiring connections	08
THX 2 Installation recommended with default set filter	09
THX 2 Installation with door mounted tweeter	10
THX 2 Tweeter Level Adjustment	11
THX 2 LFS (Low Frequency Shaping): Adjusting Low Frequency Response to eliminate resonances	12
THX 2 How to disassemble the circuit board "Step 1" "Step 2"	13
THX 2 How to disassemble the circuit board "Step 3" "Step 4"	14
THX 2 Modifications on the single components	15
<b>THX mh</b>	
THX mh Mono-Wiring connections	17
THX mh Bi-Wiring connections	18
THX mh Installation recommended with default set filter	19
THX mh Installation with door mounted midrange	20
THX mh Tweeter Level Adjustment	21
THX mh Midrange Hi-pass: Activation of the High-pass filter for the midrange"	22
THX mh How to disassemble the circuit board "Step 1" "Step 2"	23
THX mh How to disassemble the circuit board "Step 3" "Step 4"	24
THX mh Modifications on the single components	25
<b>THX 3</b>	
THX 3 Mono-Wiring connections	27
THX 3 Bi-Wiring connections	28
THX 3 Tri-Wiring connections	29
THX 3 Installation recommended with default set filter	30
THX 3 Installation with door mounted midrange	31
THX 3 Installation with door mounted double woofer	32
THX 3 Installation with door mounted double woofer and midrange	33
THX 3 Tweeter Level Adjustment	34
THX 3 Midrange Level Adjustment	35
THX 3 LFS (Low Frequency Shaping): Adjusting Low Frequency Response to eliminate resonances	36
THX 3 How to disassemble the circuit board "Step 1" "Step 2"	37
THX 3 How to disassemble the circuit board "Step 3" "Step 4"	38
THX 3 Modifications on the single components	39
<b>Technical Specifications</b>	40



# THESIS

## The Project

In order to create a system capable of reproducing amazing, first-class Sound, each acoustical component must abide to the most elevated standards of quality and design.

The Thesis amplifiers offer their best performance when used with speakers designed with the same philosophy. Throughout the years Thesis has represented a name referenced to the perfection of electronic design and performance. Today, technological development has enabled us to push the envelope in terms of the prestigious Thesis tradition. Creating a supreme product in amplification, the Audison development team has achieved their ambition of reproducing an unparalleled Sound.

## Appropriate tuning

Assembling a speaker system imposes choices in which parameters such as personal taste, the physical installation limits and the acoustic environment of the vehicle itself have to be considered.

Thesis speakers ensure the highest performance with both multi-amplified active systems and with systems using "passive" crossovers.

Pairing TH speakers with the TH amplifiers intensifies the synergy of products belonging to the same magnificent project. Therefore, choosing an active multi-amplified system or the use of passive crossovers is merely a question of personal taste.

The available crossover networks are:

THX 2, for a full range two-way system with TH 1.5 violino and TH 6.5 sax;

THX 3, for a full range three-way system with TH 1.5 violino, TH 3.0 voce and TH 6.5 sax;

THX mh, for a mid to high frequency system with TH 3.0 voce and TH 1.5 violino as part of a "mixed" multi-way system.

## Open design

Each filter is, in actual fact, an "open" design which can be customised in order to obtain the best acoustic response in any environment.

## Extreme customization

A mother board, designed for maximum versatile adaptation, provides the ability for anyone to customize their own THX crossover.

Designed as a continued project in-progress, it is possible to change and set:

- the power connection mode for BiWiring or when used as a passive multi-amplified system;
- the output level of every single speaker;
- the cut-off frequency of every single output;
- the filter cut-off slope;
- the Q (quality factor) at the crossover frequency;
- the use of notch filters to adjust the system to the vehicles acoustics.

## Audison Thesis Advisor

The THX crossover default configuration has been designed to achieve the highest sound quality levels. This Advanced Manual offers complete information to fully enjoy their potential.

Each user has at his/her disposal the best support to make the most of the Thesis line expandability and customization possibilities. Through the "Support" area of the Audison website the user can interact with the Audison Thesis Advisor to be guided by a professional inside the Audison R&D Division who will provide him/her with the opportunity to further enhance their crossover.

A mother board, designed for maximum versatile adaptation, provides the ability for the users to customize their own THX crossover.

## Assembling

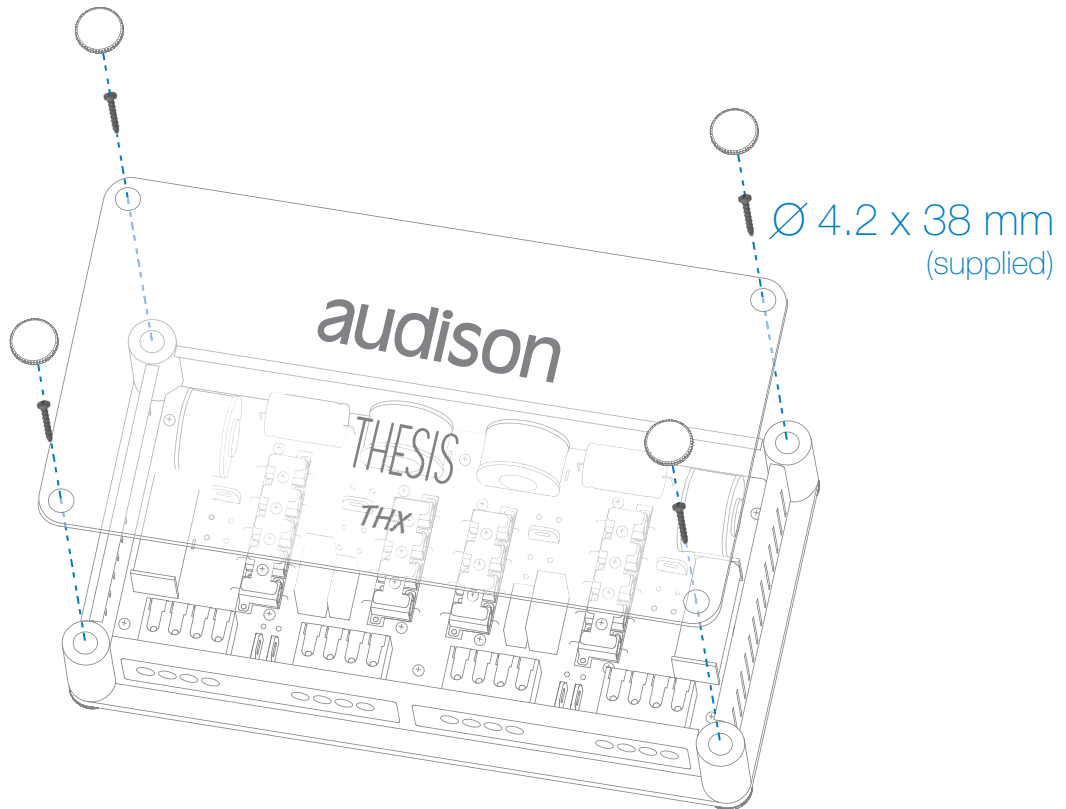

## Cable connection

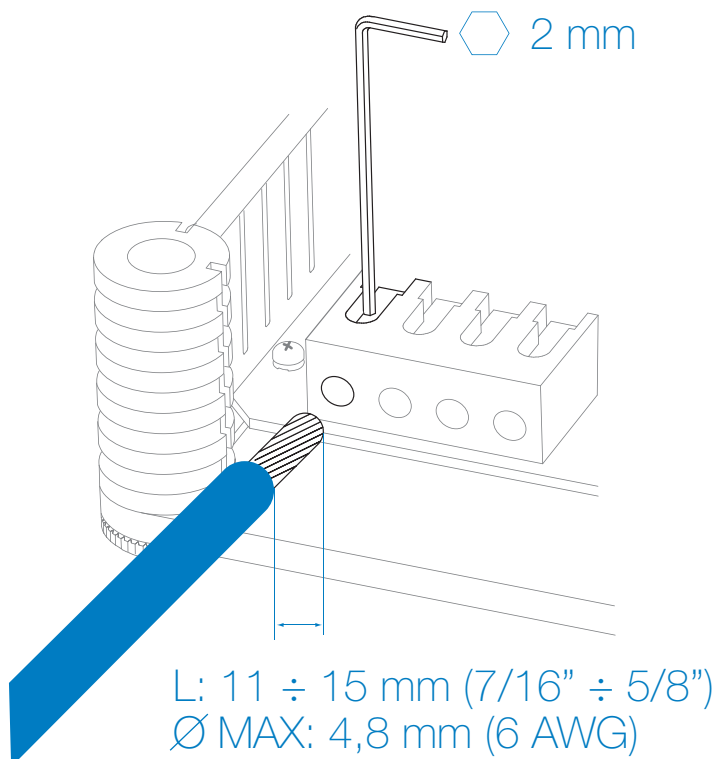

# Size

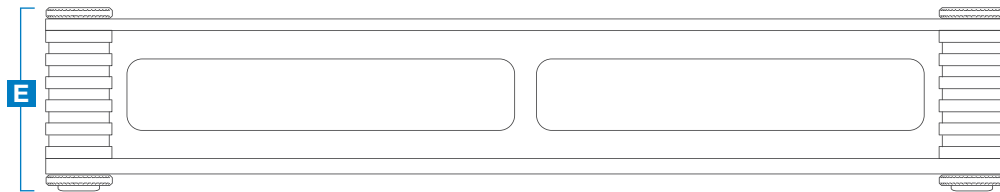
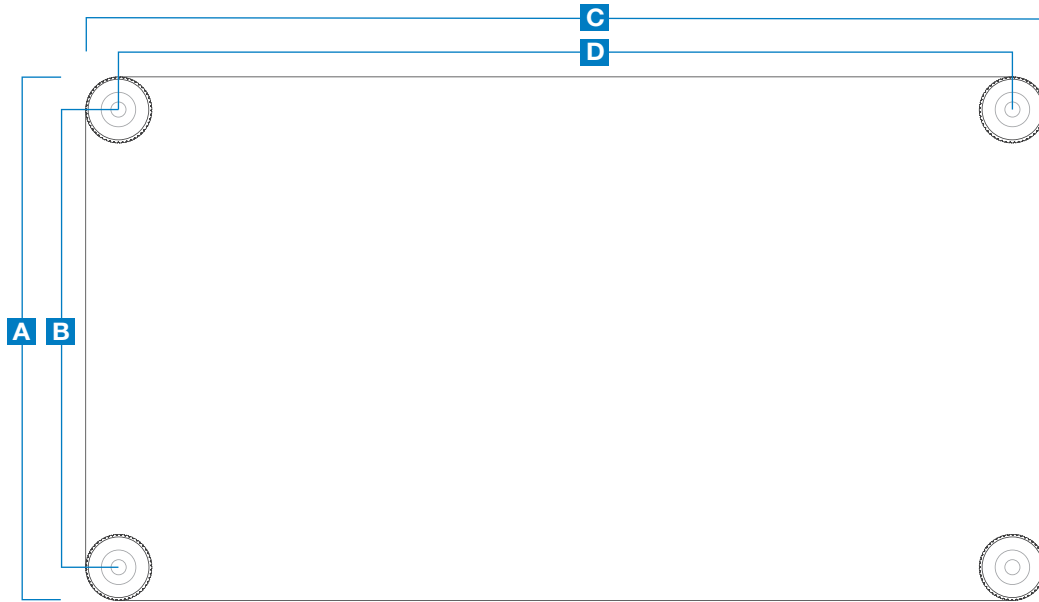

	A	B	C	D	E
THX 2	190	166	348	324	66,5
THX mh	7 <sup>11</sup> / <sub>2</sub>	6 <sup>11</sup> / <sub>2</sub>	13 <sup>3</sup> / <sub>4</sub>	12 <sup>3</sup> / <sub>4</sub>	2 <sup>5</sup> / <sub>8</sub>
THX 3	258	234	438	414	66,5
	10 <sup>3</sup> / <sub>16</sub>	9 <sup>1</sup> / <sub>4</sub>	17 <sup>1</sup> / <sub>4</sub>	16 <sup>5</sup> / <sub>16</sub>	2 <sup>5</sup> / <sub>8</sub>

Misure espresse in millimetri e pollici / Measures in mm and inches

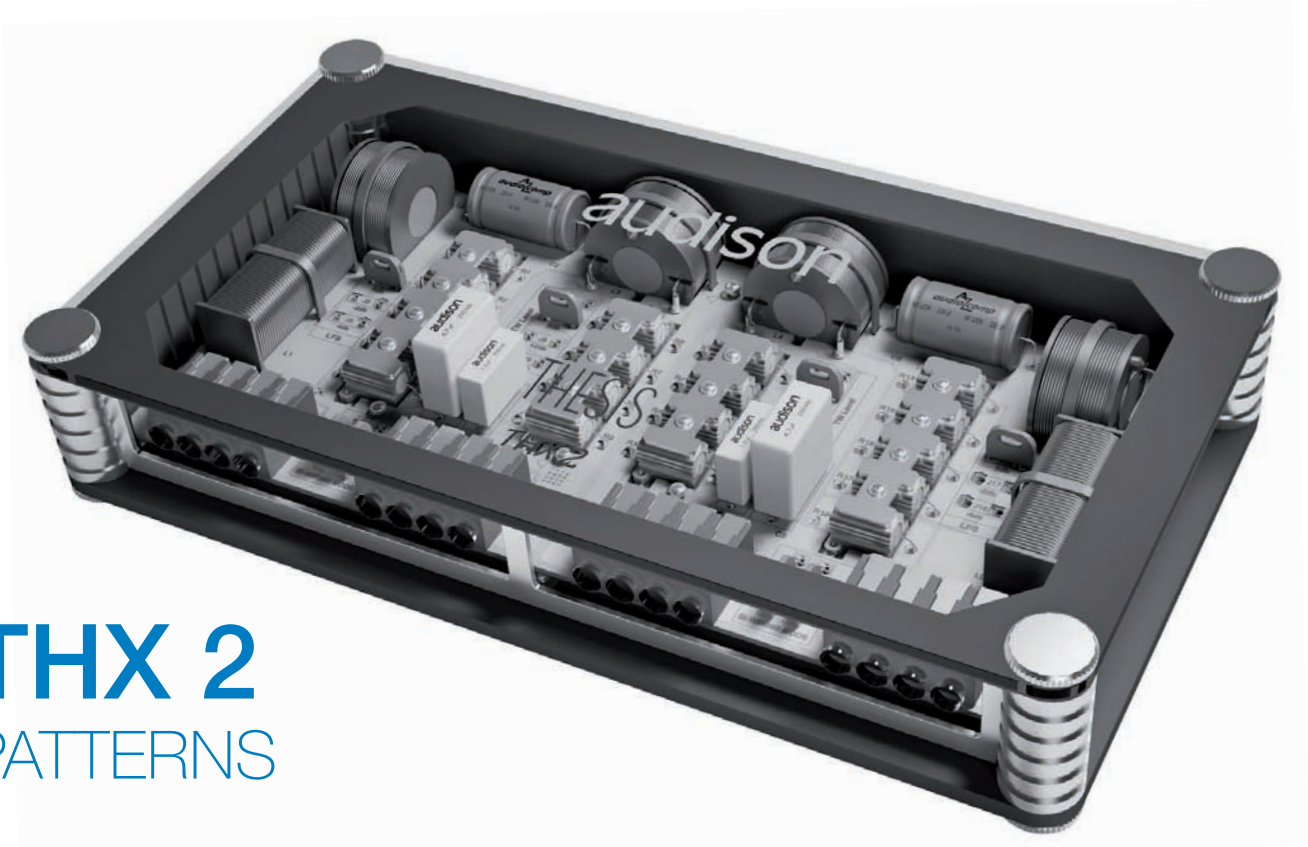

# THX 2

## PATTERNS

### TUNING KIT (supplied)

N° 2 1Ω, 10W Resistors

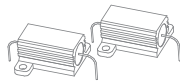

N° 2 2,2Ω, 10W Resistors

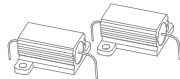

N° 2 3,3Ω, 10W Resistors

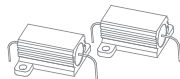

N° 2 4,7Ω, 10W Resistors

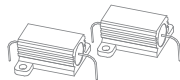

N° 2 5,6Ω, 10W Resistors

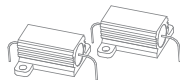

N° 2 1μF, 330V Polypropylene capacitors

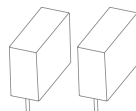

N° 4 4,2x38 mm cross headed,  
self-tapping fixing screws

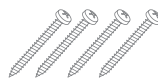



# THX 2 Mono-Wiring connection

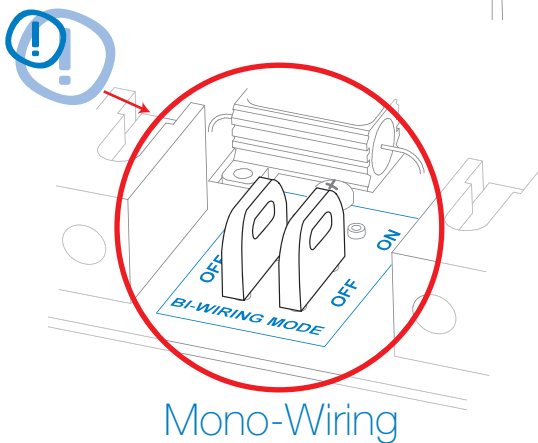
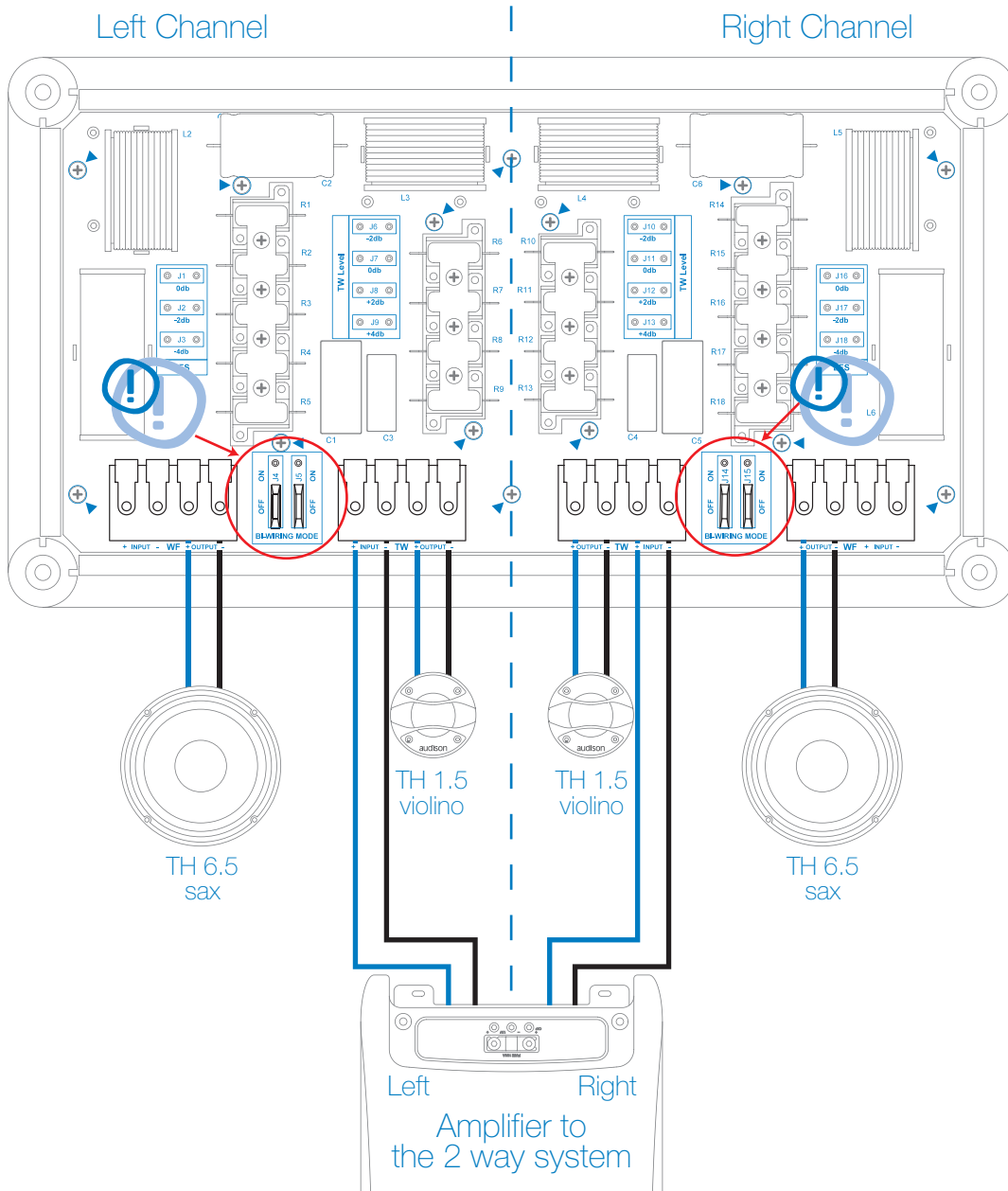



# THX 2 Bi-Wiring connection

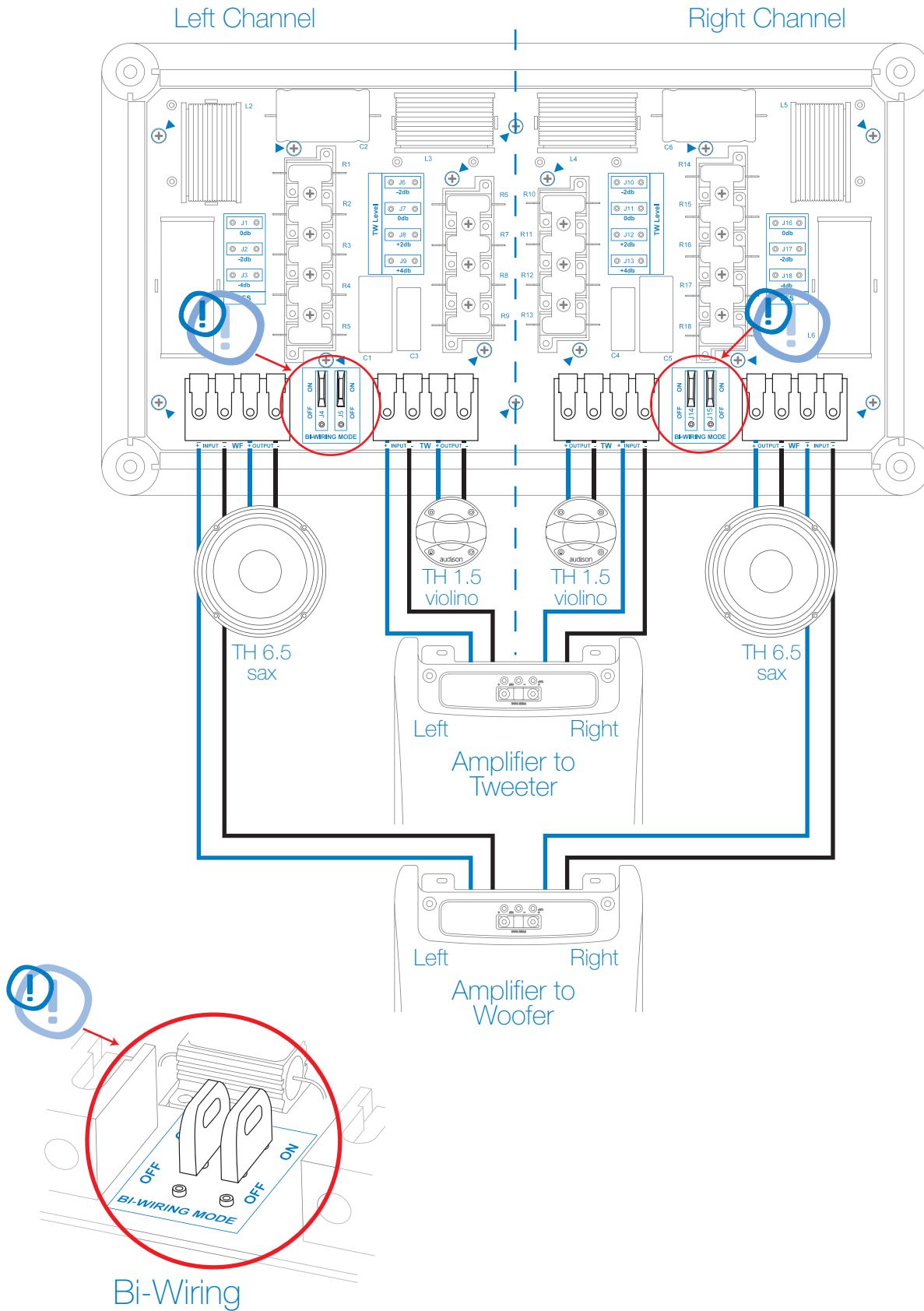





# THX 2 Installation recommended with default set filter

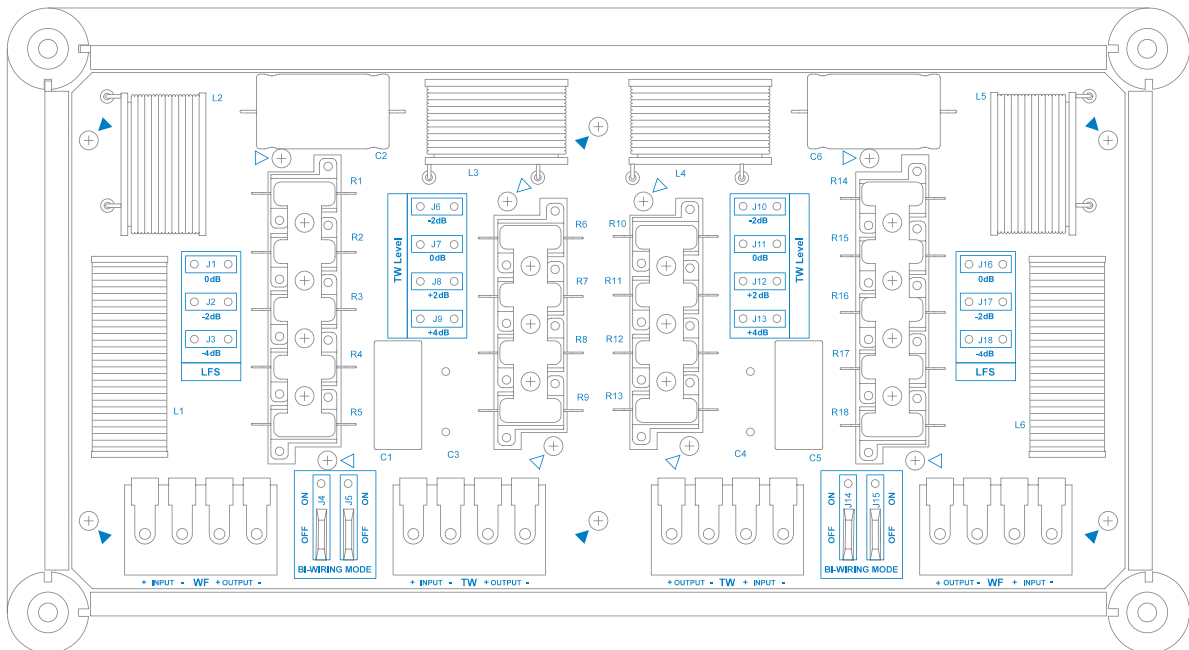
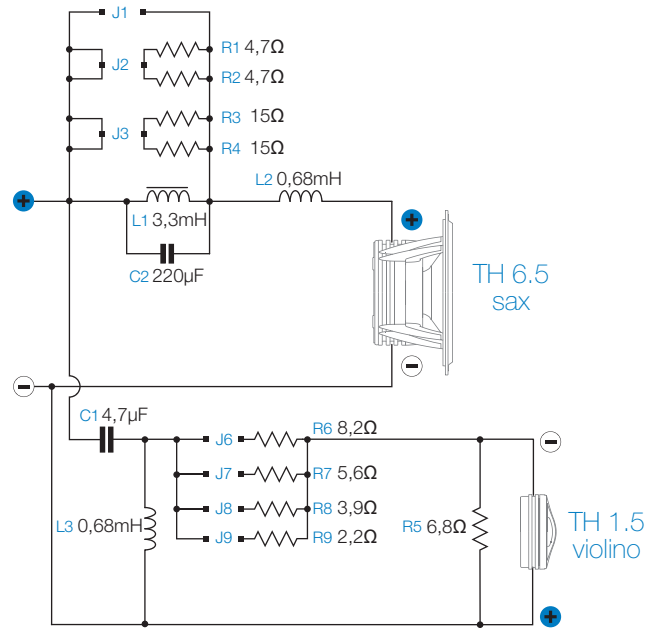
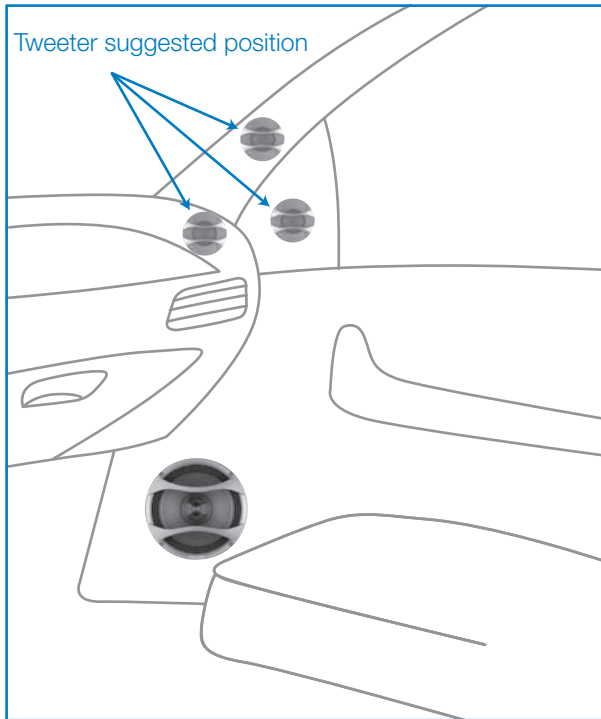



# THX 2 Installation with door mounted tweeter

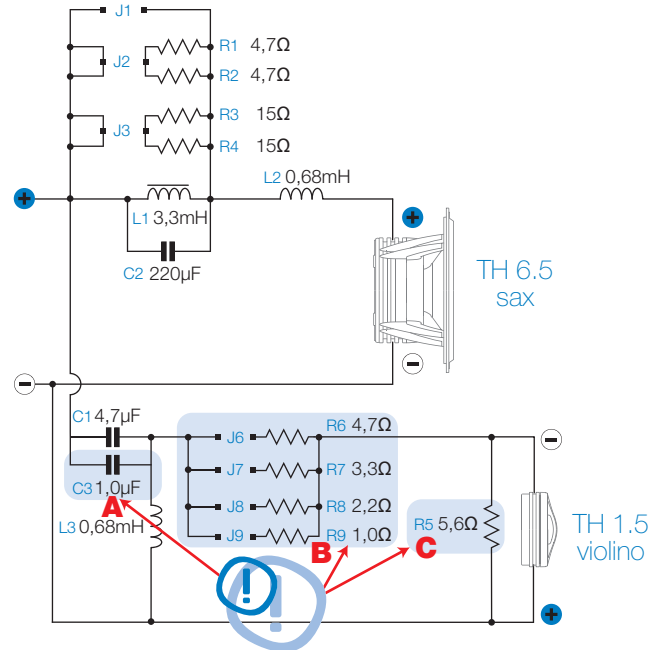
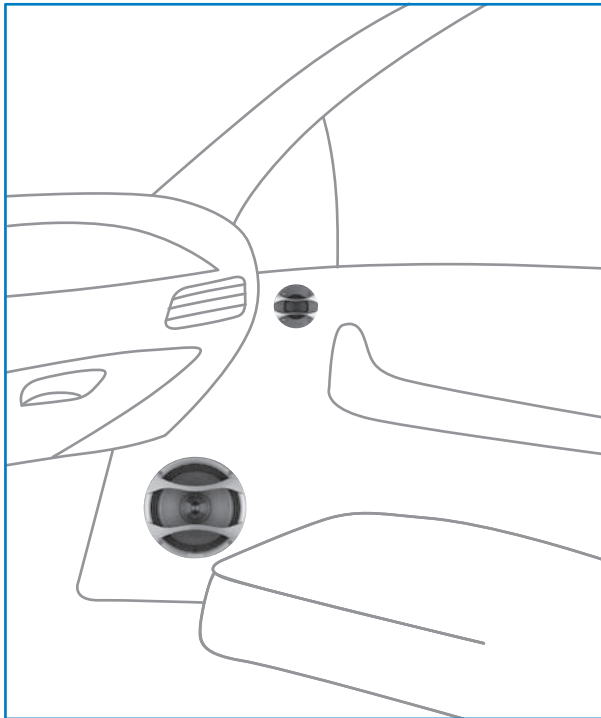

Left Channel

Right Channel

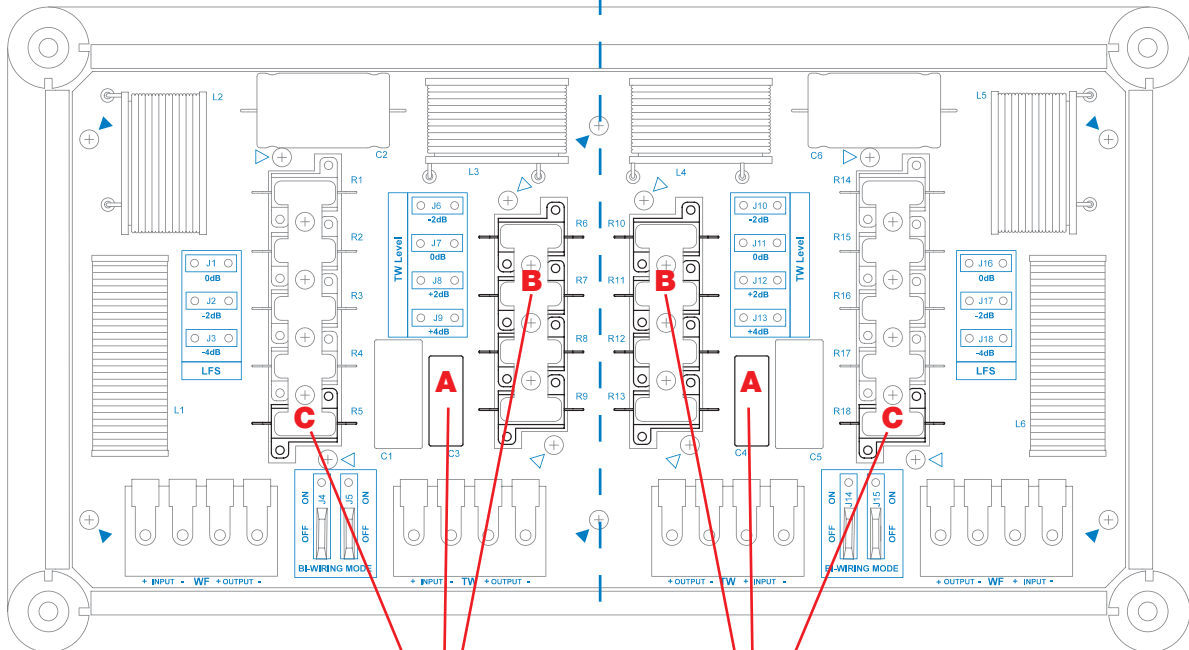

WORK ON THESE COMPONENTS! (see page 13÷15)



# THX 2 Tweeter Level Adjustment

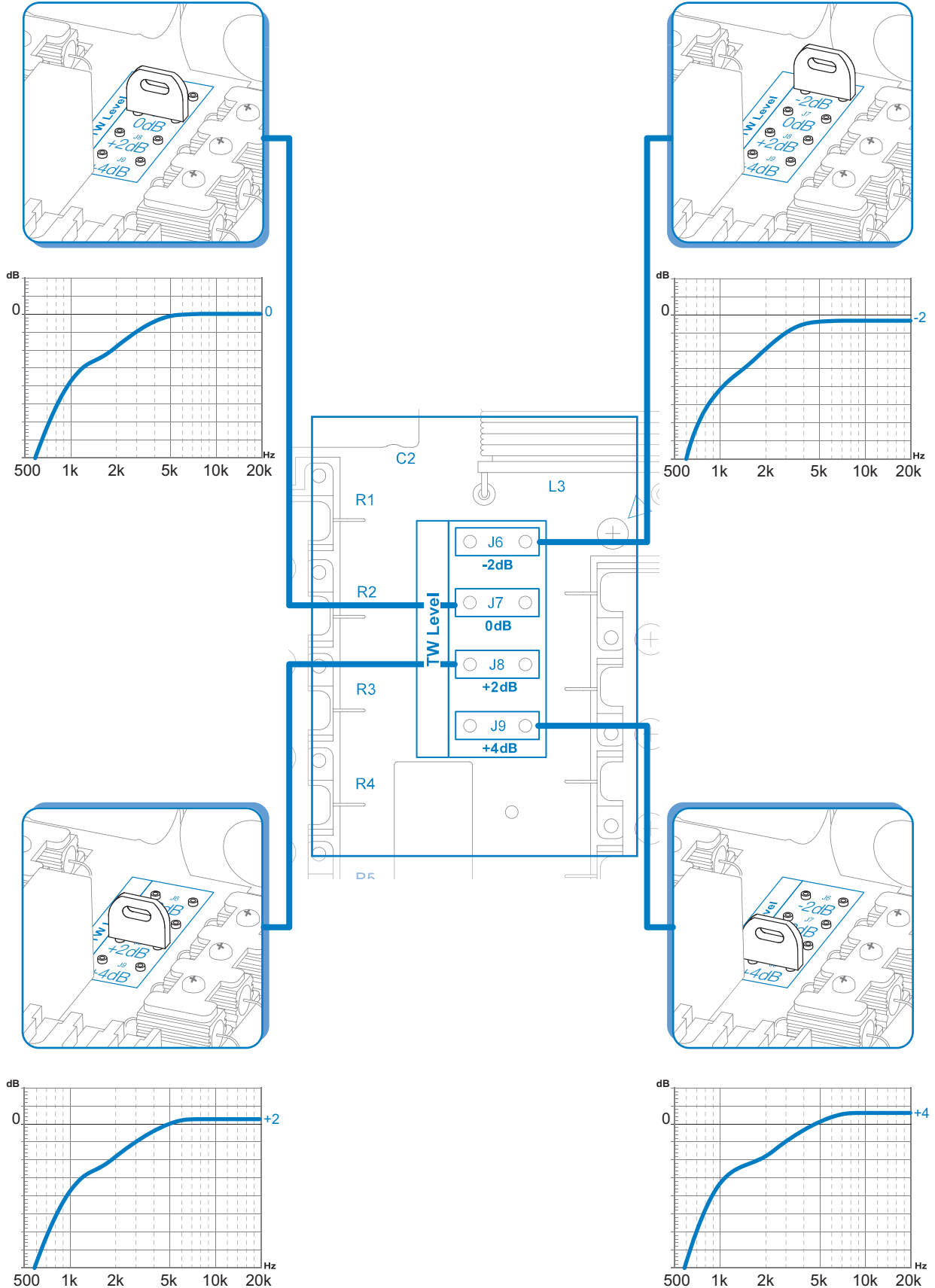



# THX 2 LFS (Low Frequency Shaping)

Adjusting Low Frequency Response to eliminate resonances

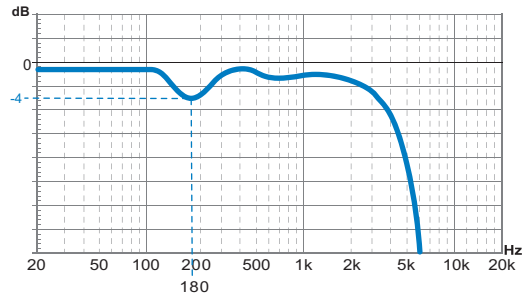
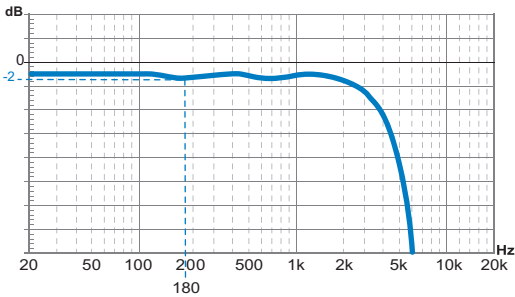
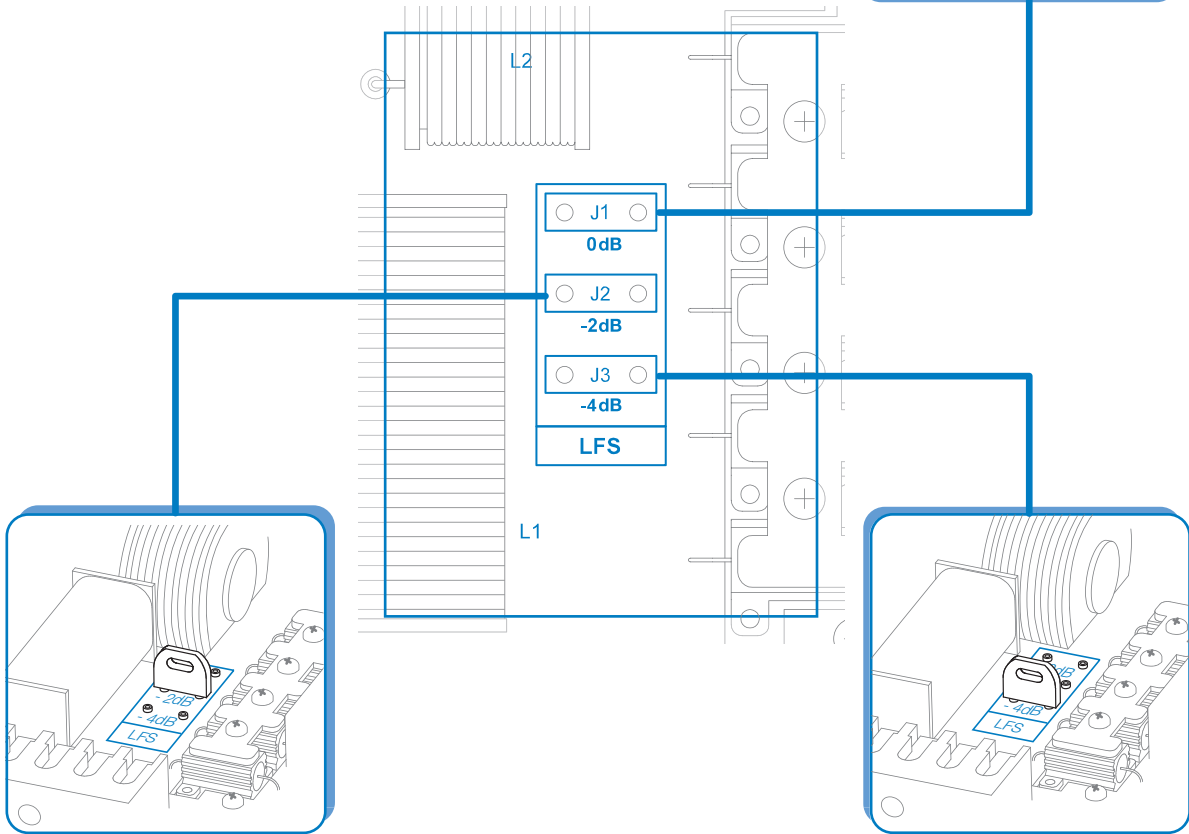
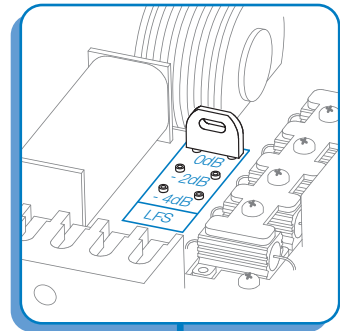
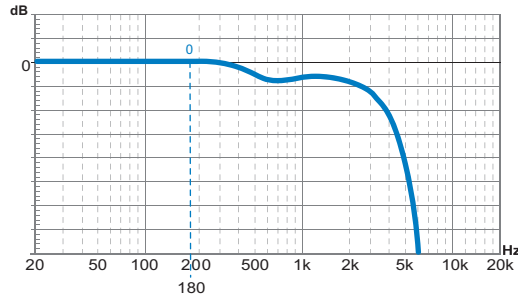



# THX 2 How to disassemble the circuit board

Step 1: remove plexiglass cover (see page 4)

Step 2: remove the main screws (marked in blue)

Left Channel

Right Channel

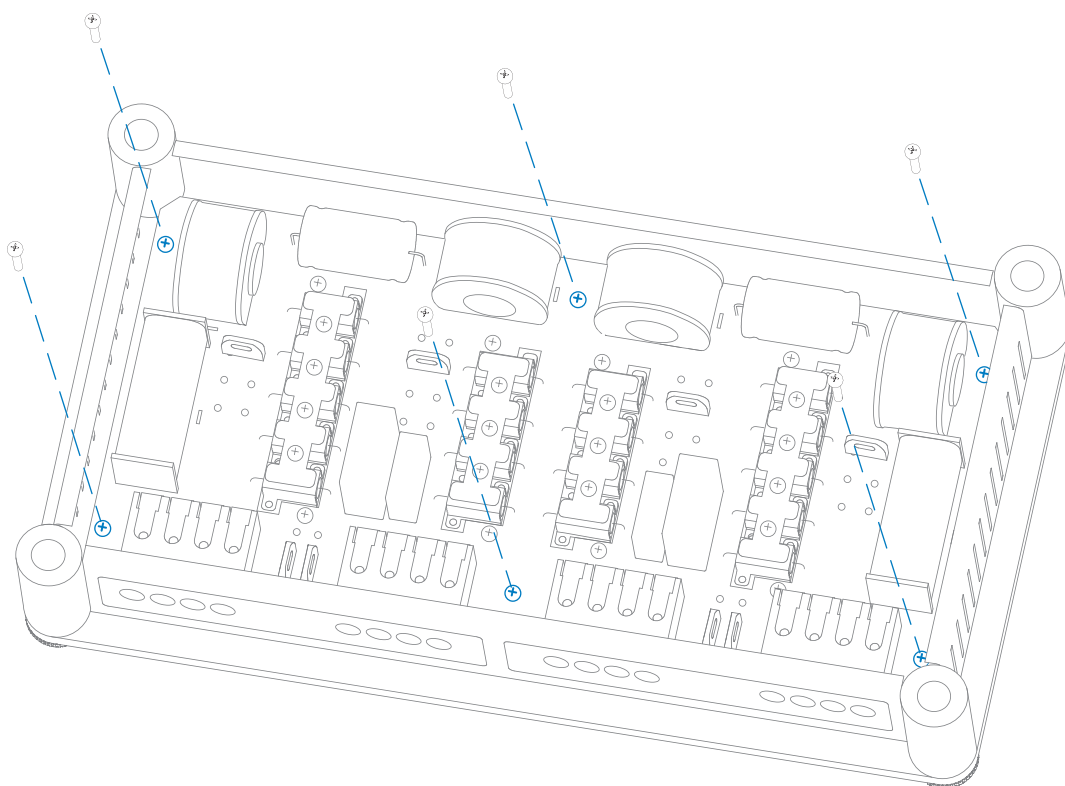
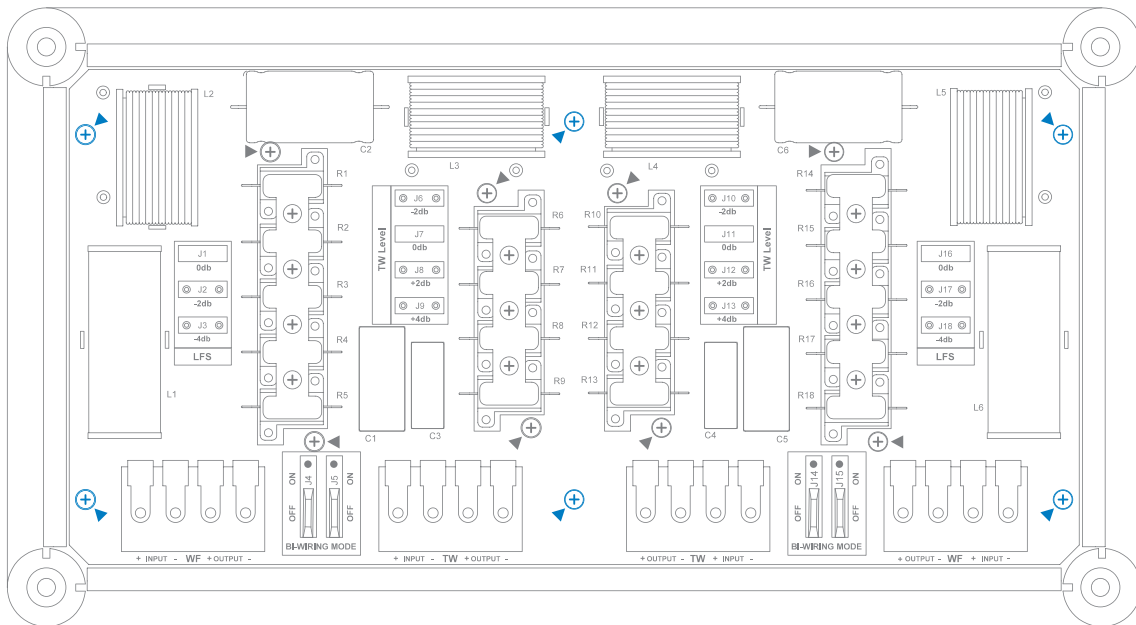

# THX 2 How to disassemble the circuit board

Step 3: remove the screws that secure the resistor blocks (marked in blue)

Step 4: remove the screws that secure the resistors with the clamps

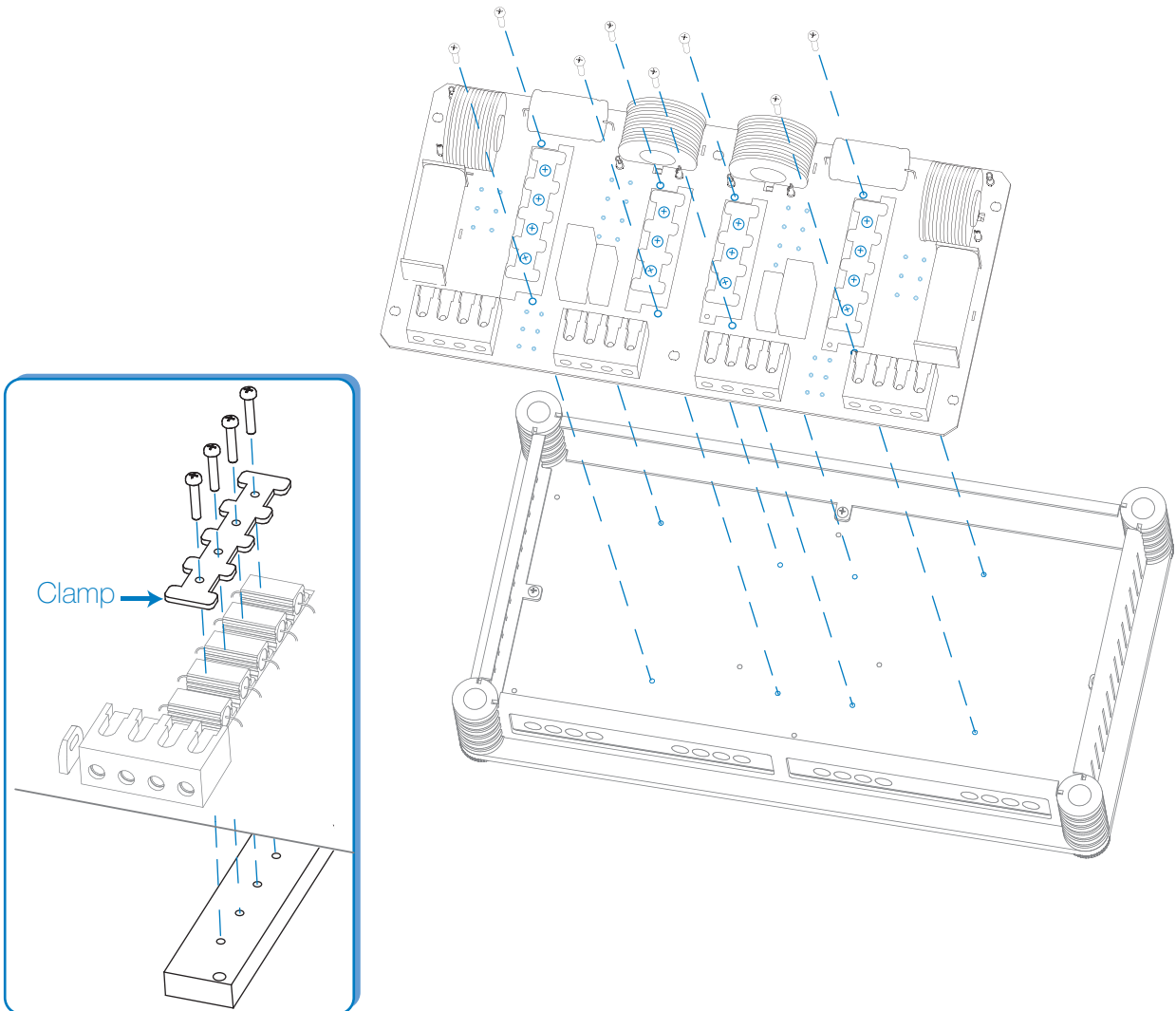
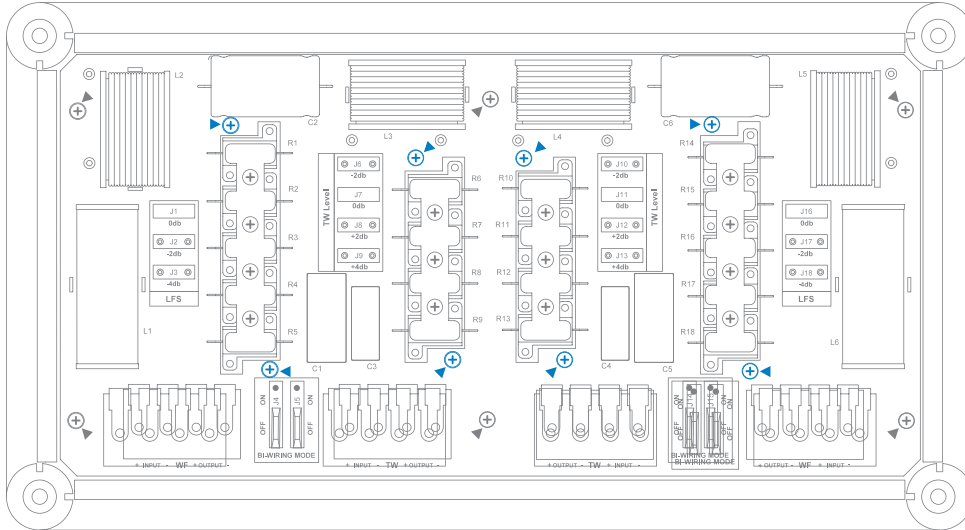

# THX 2 Modifications on the single components

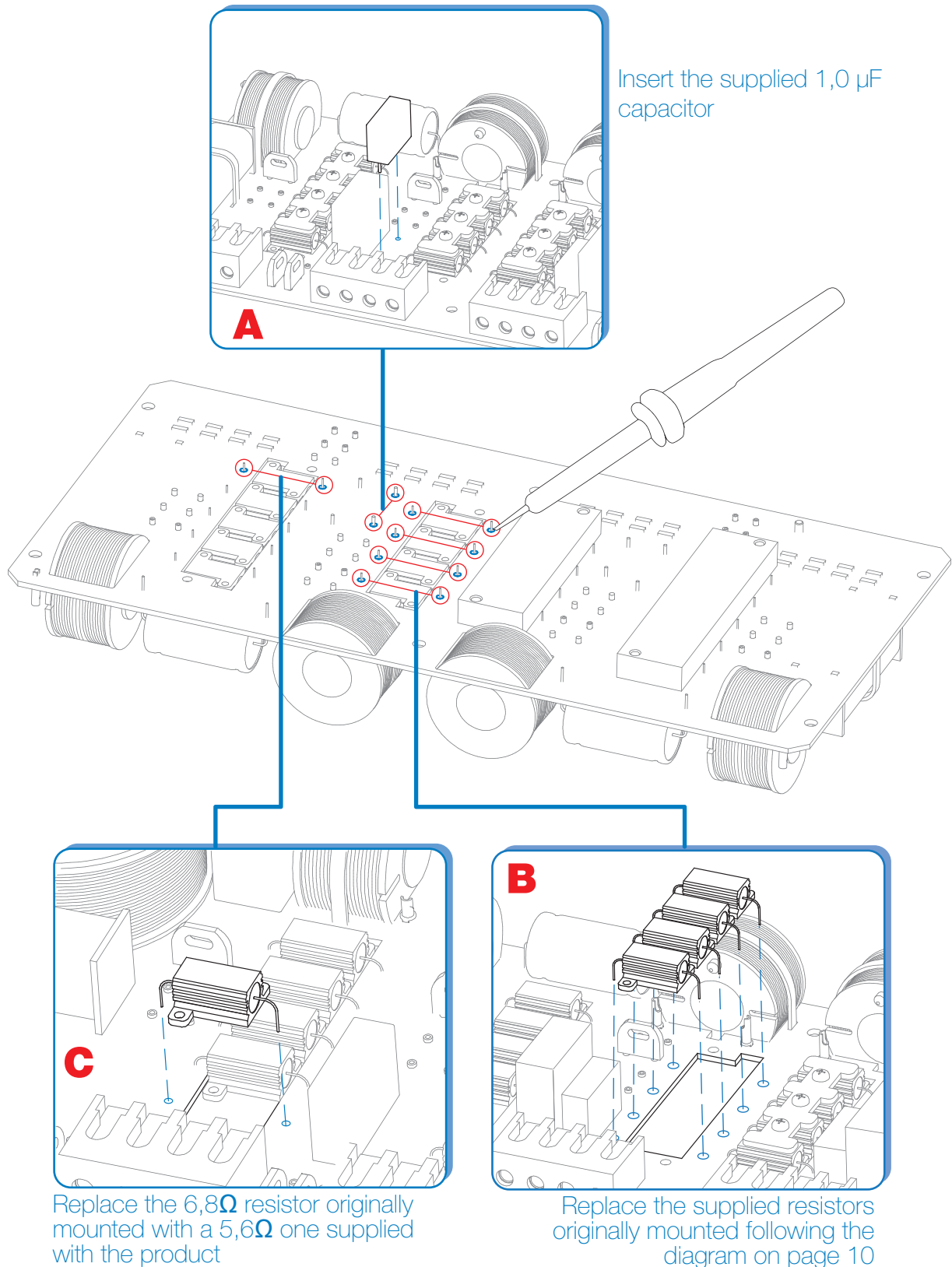

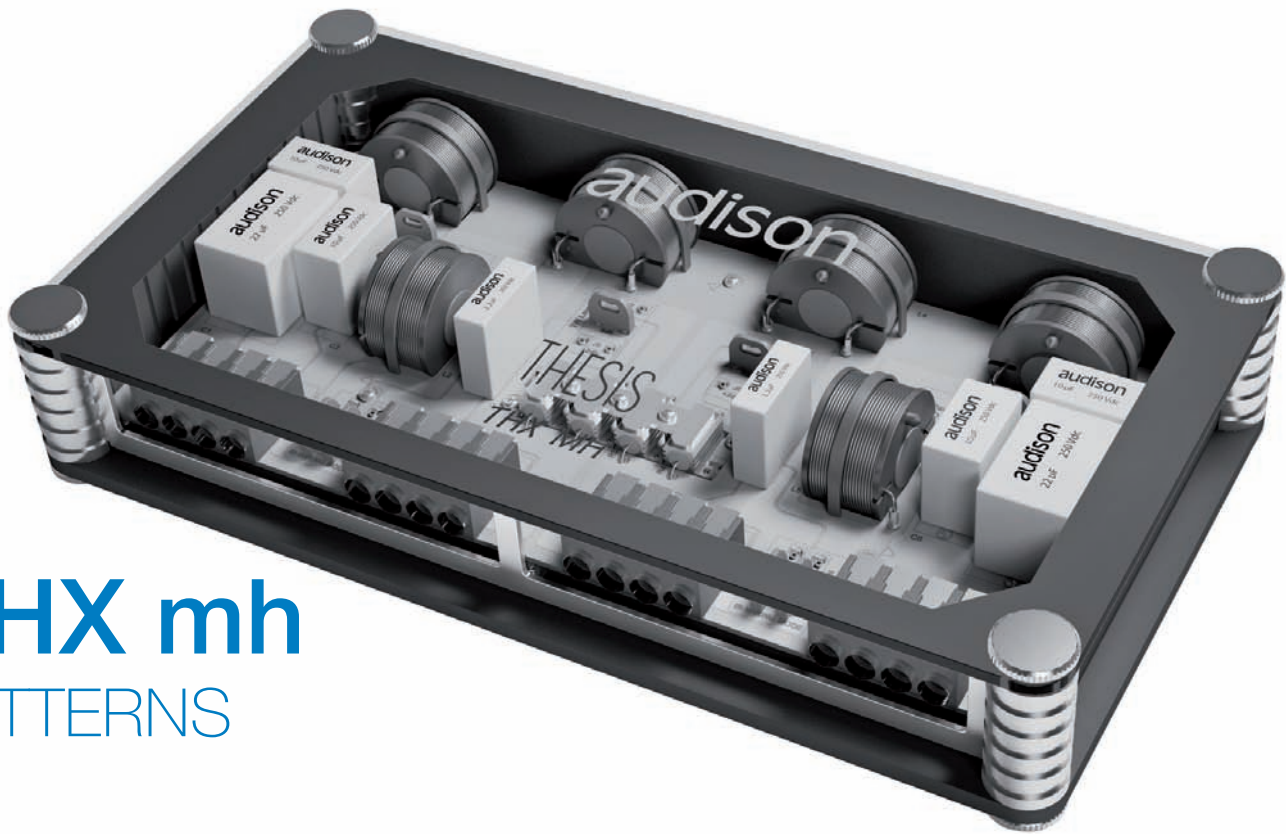

# THX mh

## PATTERNS

### TUNING KIT (supplied)

N° 2 1.5 mH, Ø 42 mm inductances

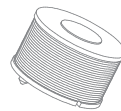

N° 2 1µF, 330V Polypropylene capacitors

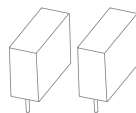

N° 4 4,2x38 mm cross headed, self-tapping fixing screws

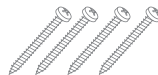





# THX mh Mono-Wiring connection

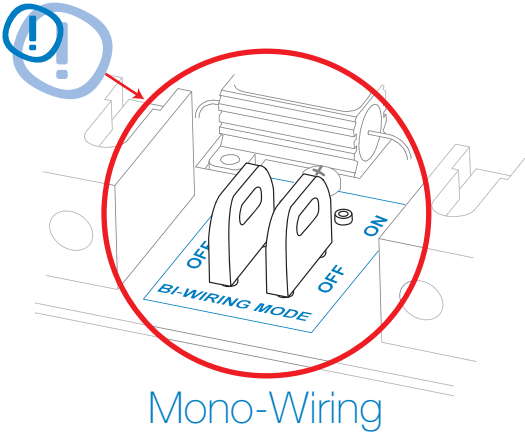
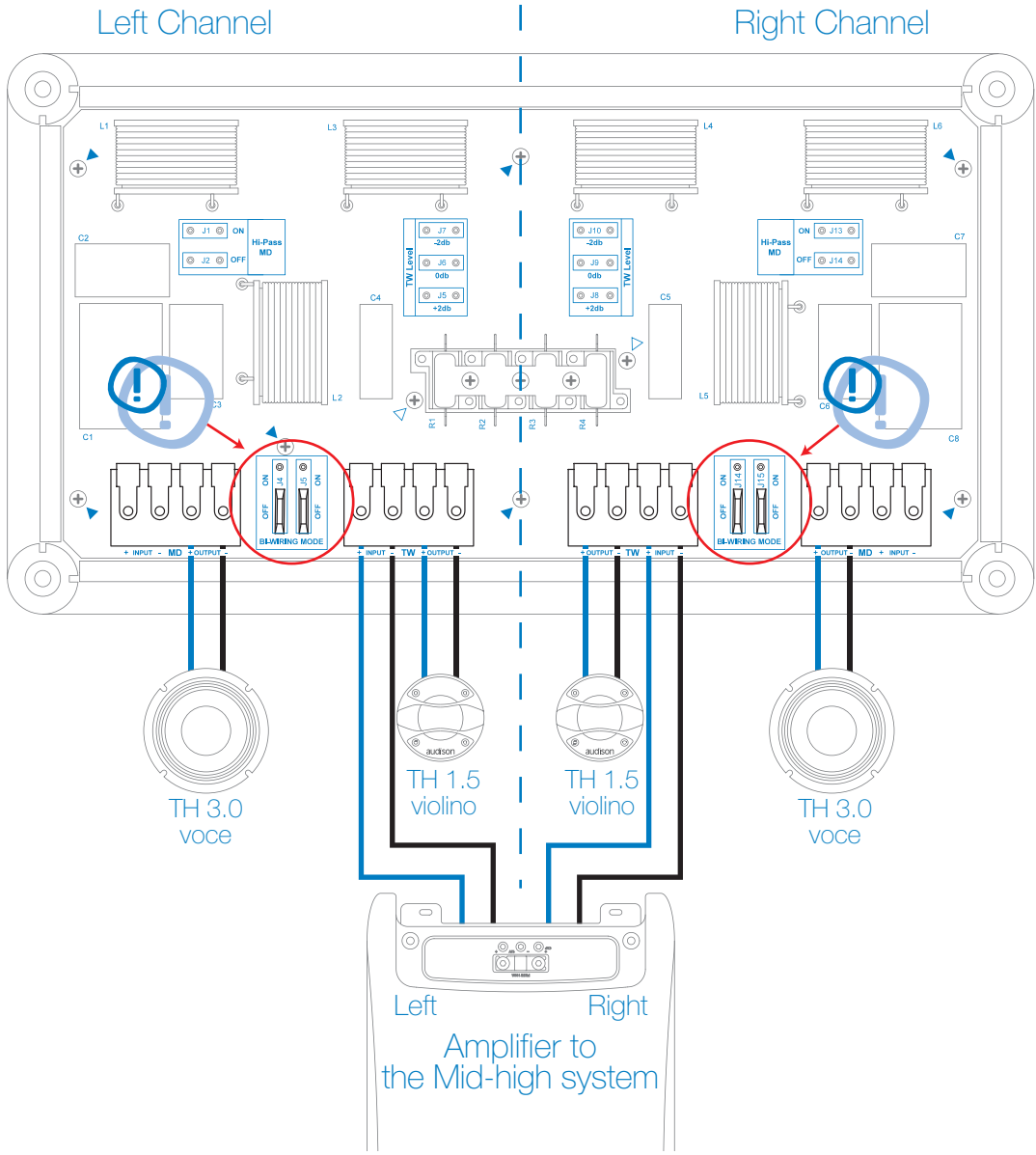



# THX mh Bi-Wiring connection

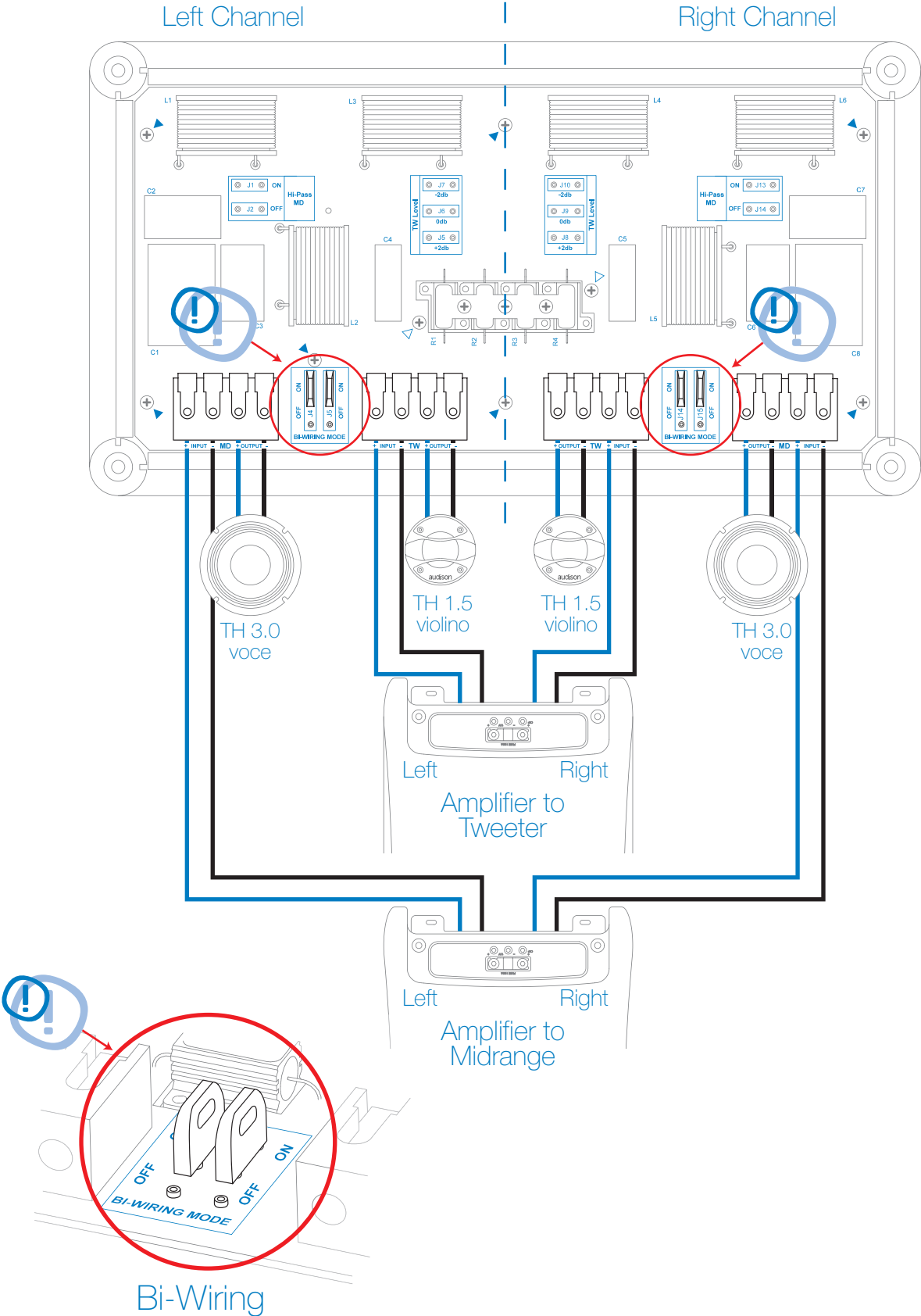

THX mh



# THX mh Installation recommended with default set filter

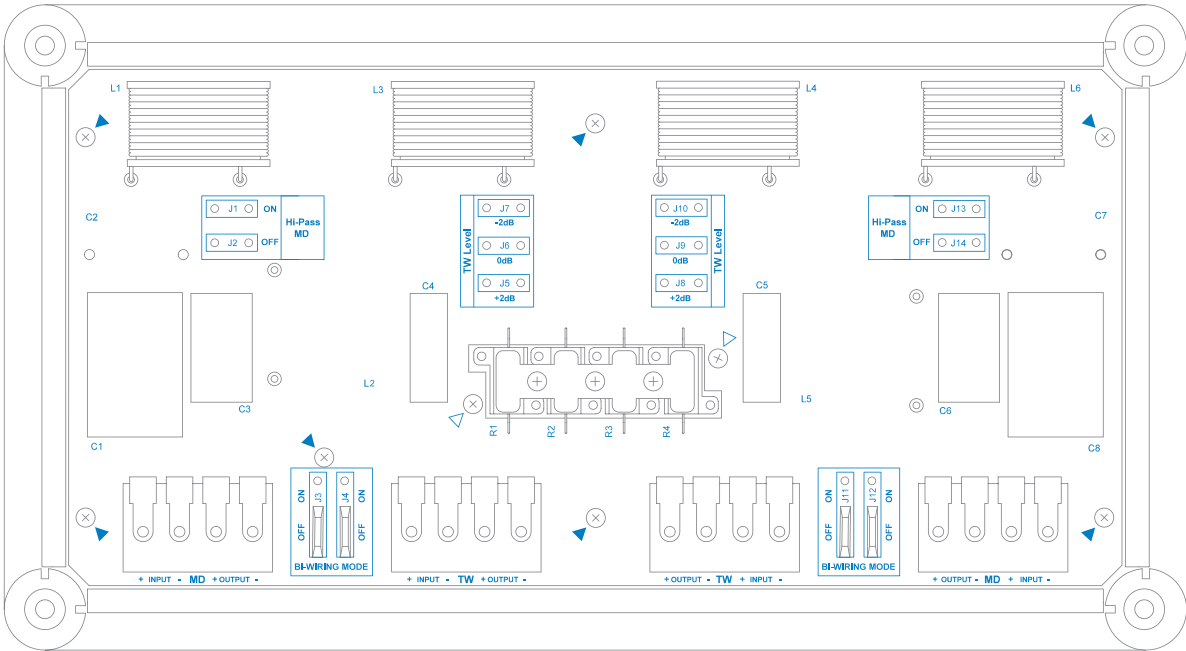
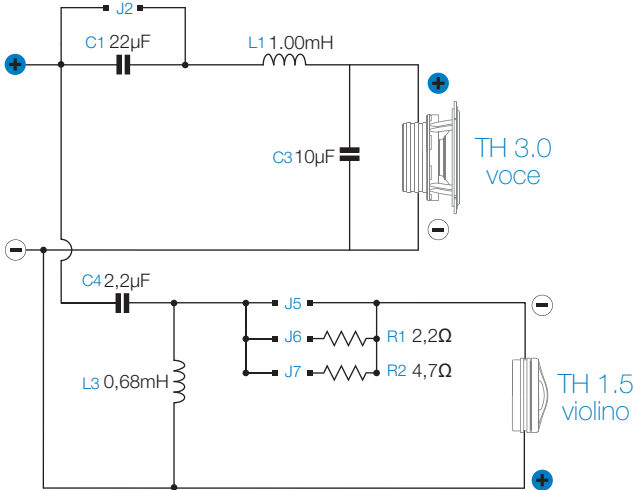
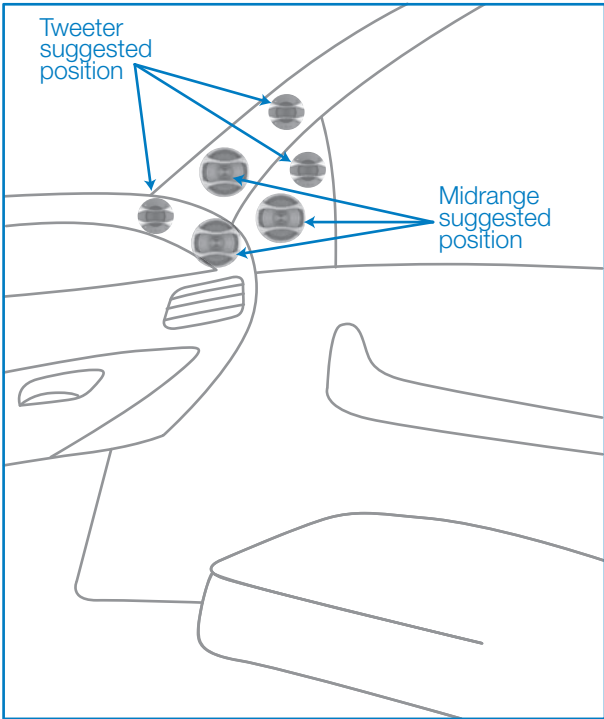

THX mh



# THX mh Installation with door mounted midrange

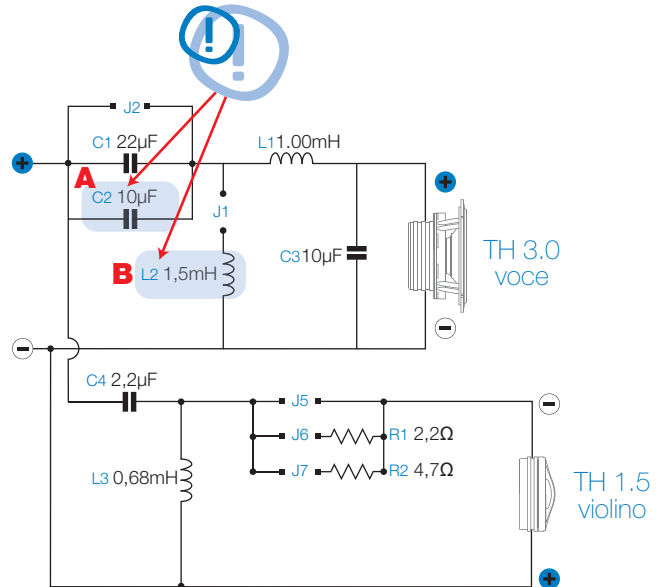
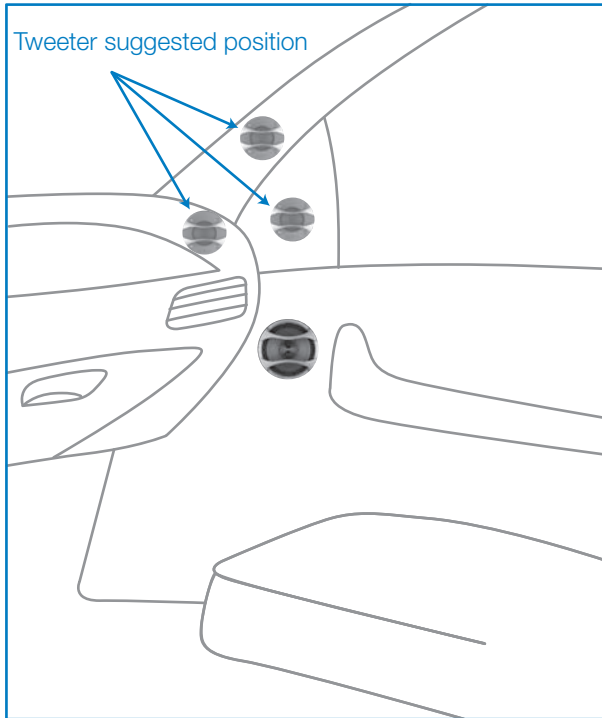

Left Channel

Right Channel

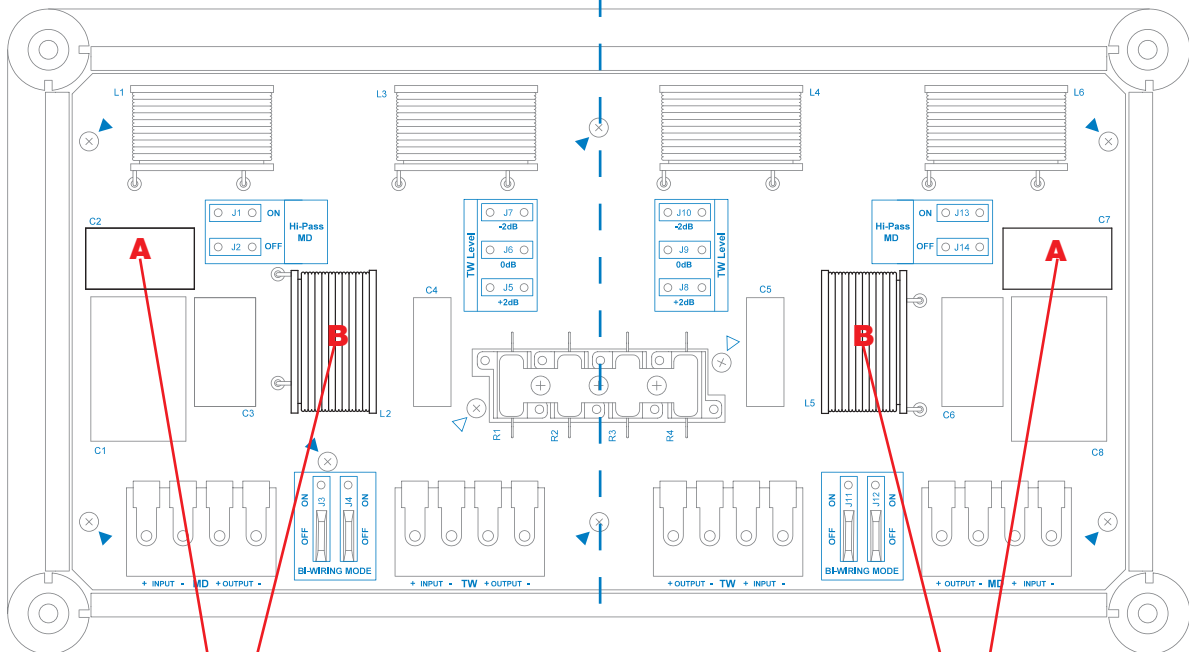

WORK ON THESE COMPONENTS! (see Page 23÷25)



# THX mh Tweeter Level Adjustment

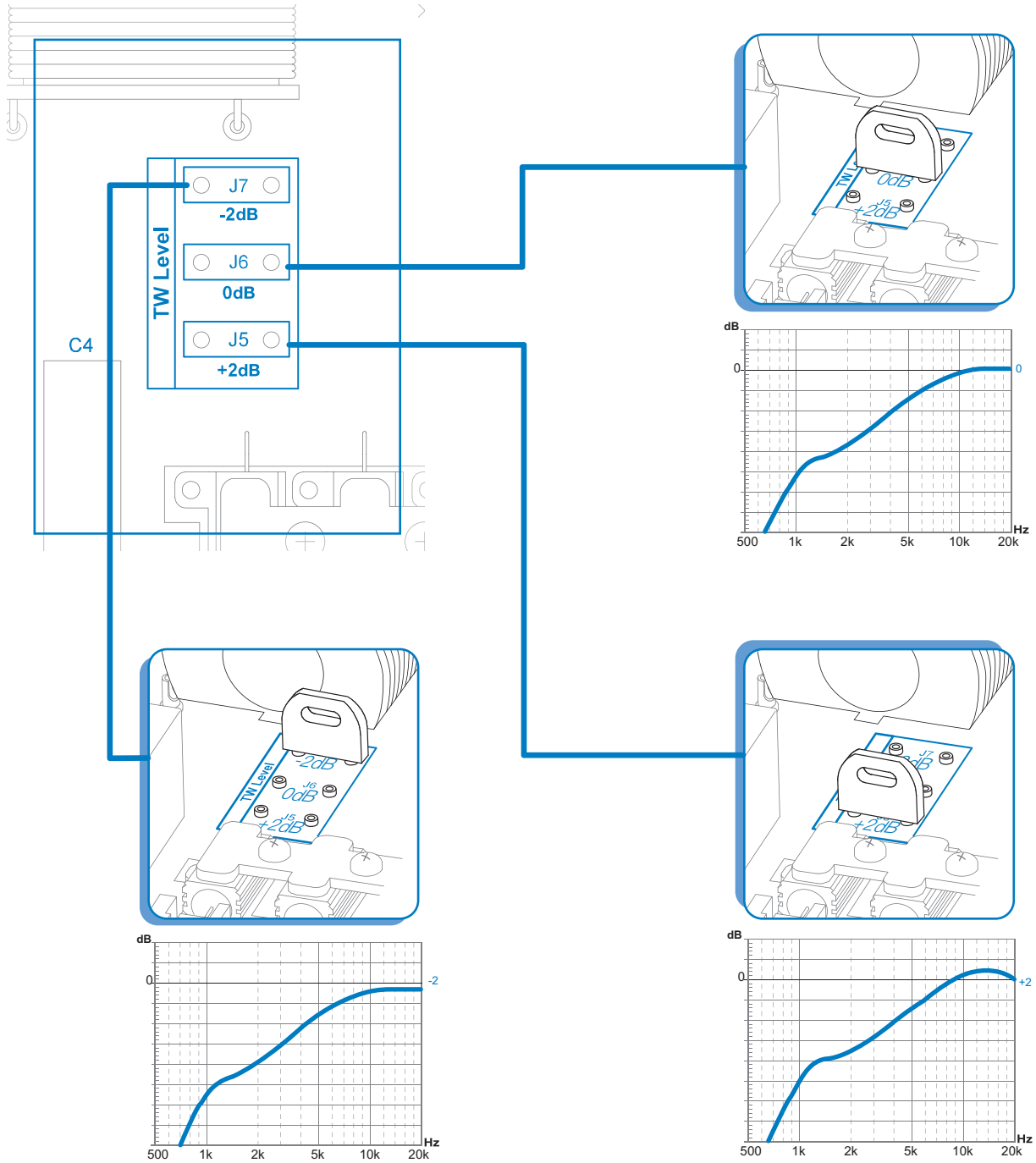

THX mh



# THX mh Midrange Hi-pass

Activation of the High-pass filter for the midrange

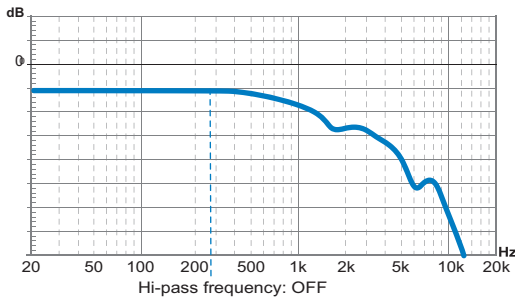
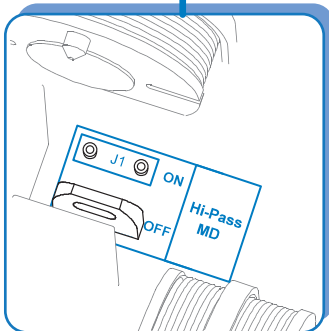
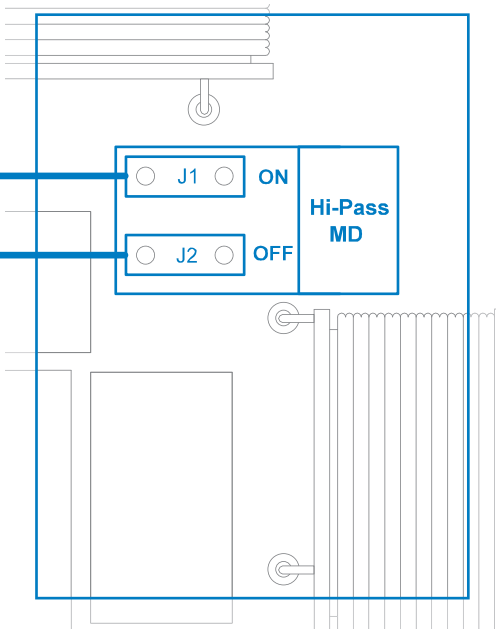
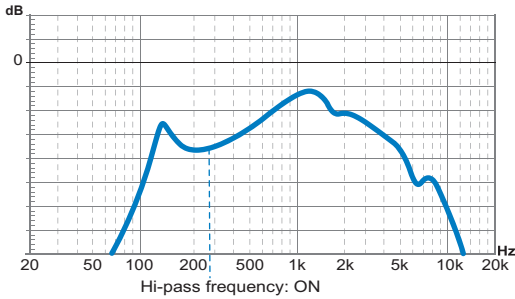
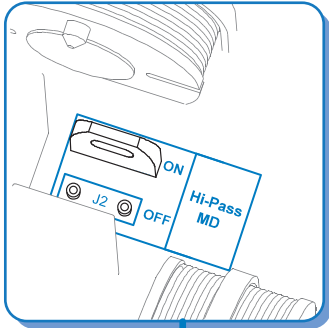

THX mh



# THX mh How to disassemble the circuit board

Step 1: remove plexiglass cover (see page 4)

Step 2: remove the main screws (marked in blue)

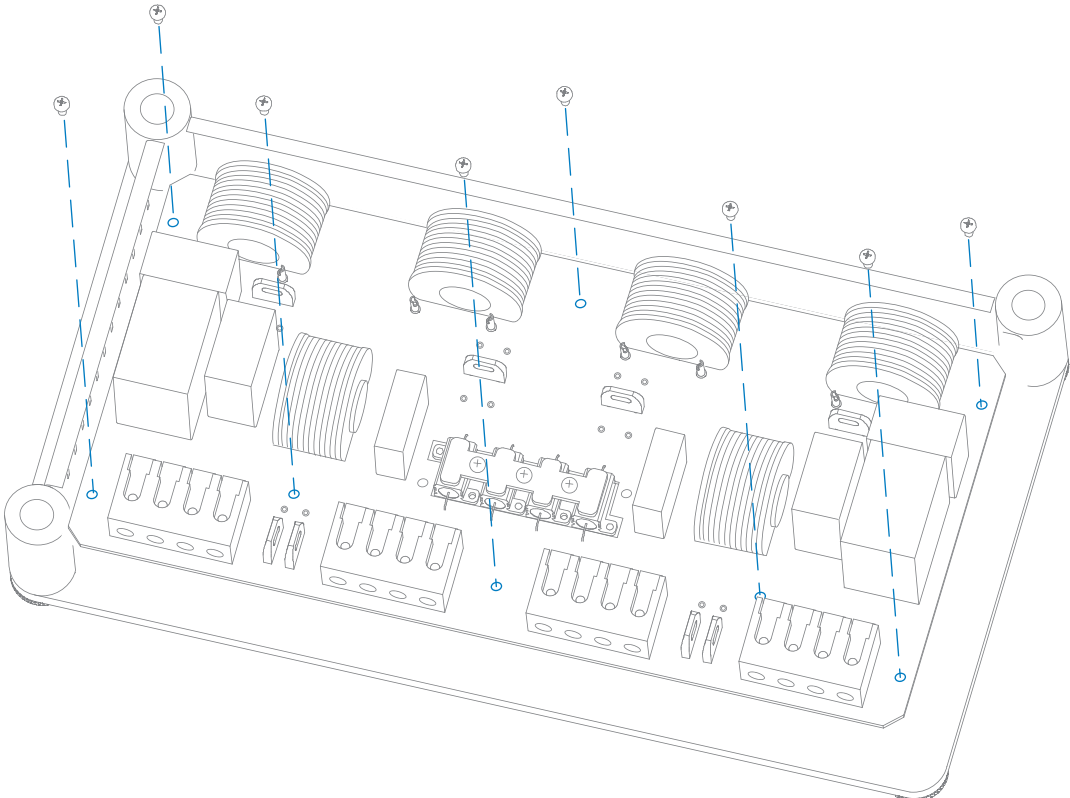
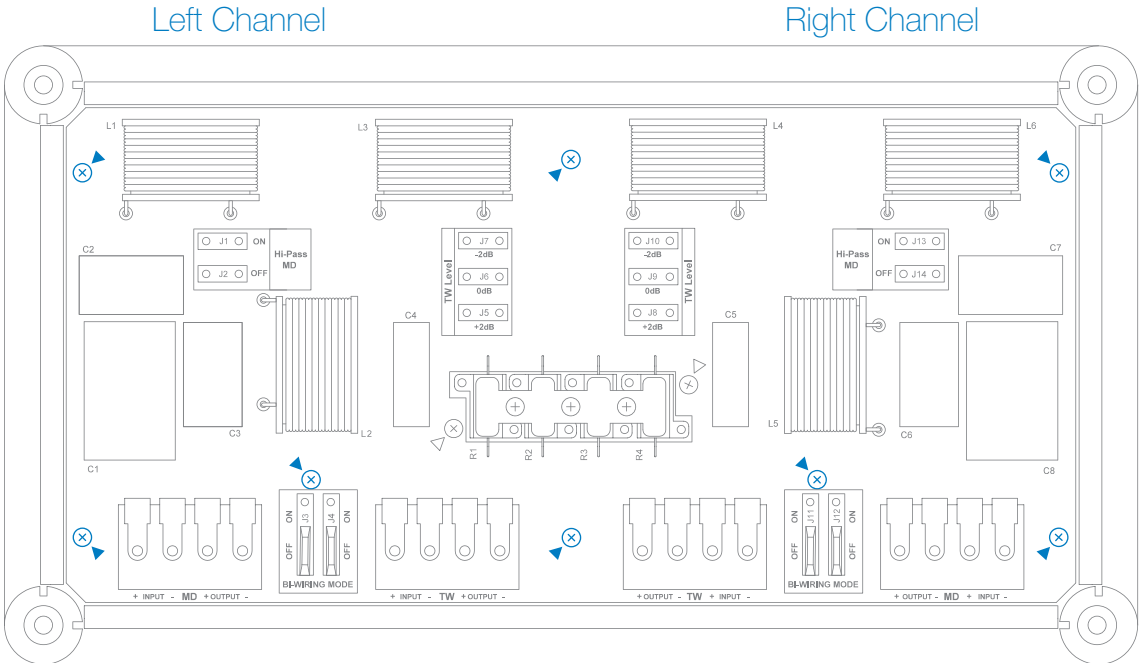

# THX mh How to disassemble the circuit board

Step 3: remove the screws that secure the resistor blocks (marked in blue)

Step 4: remove the screws that secure the resistors with the clamps

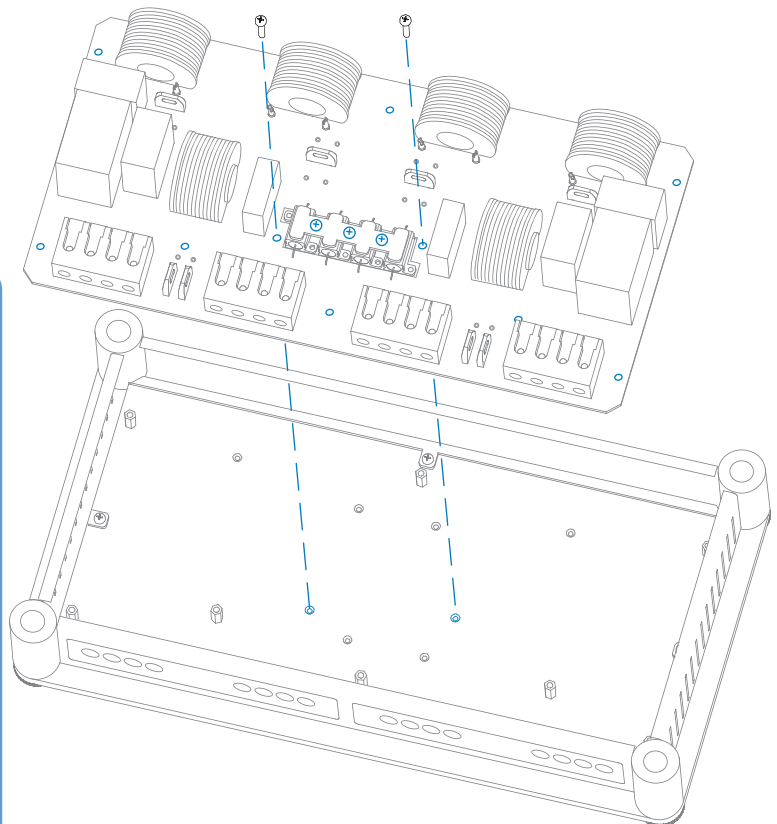
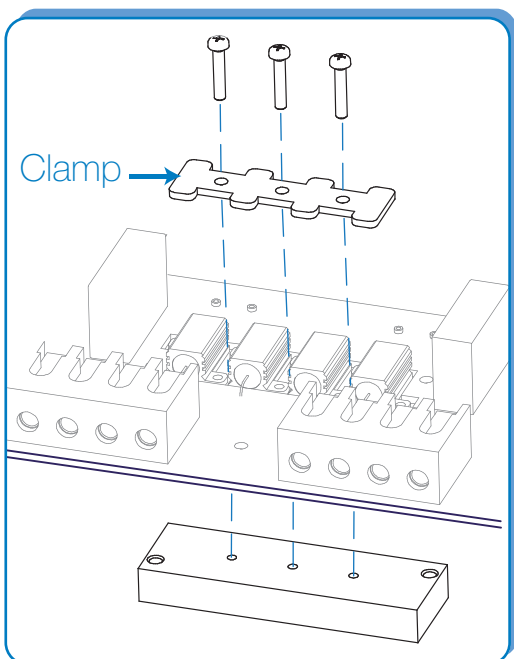
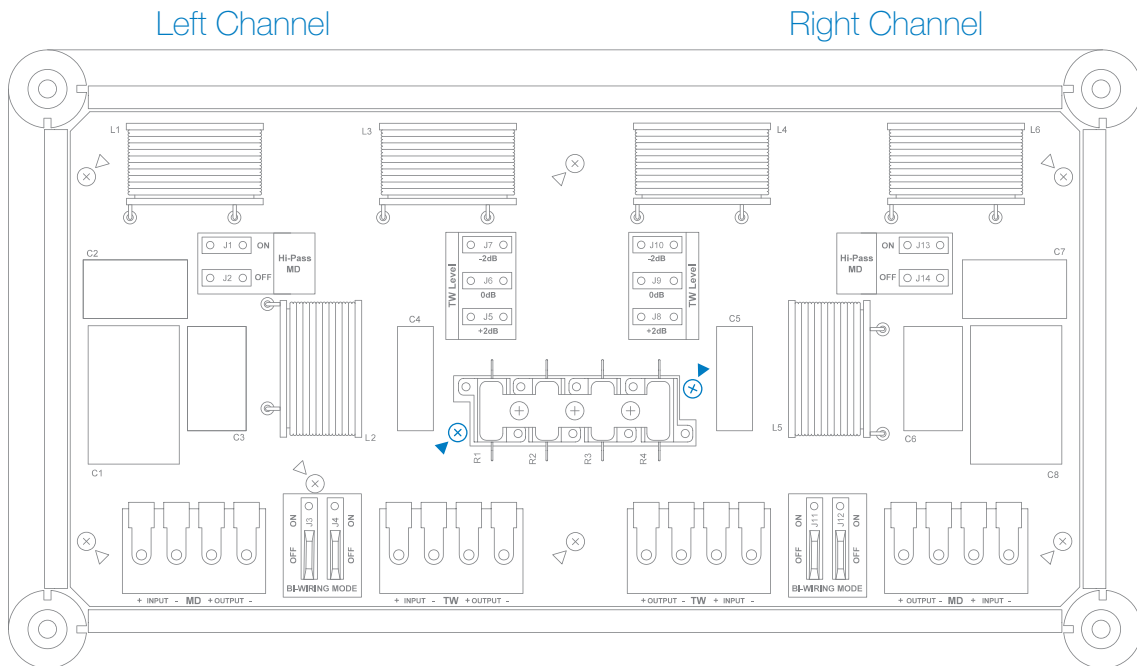



# THX mh Modifications on the single components

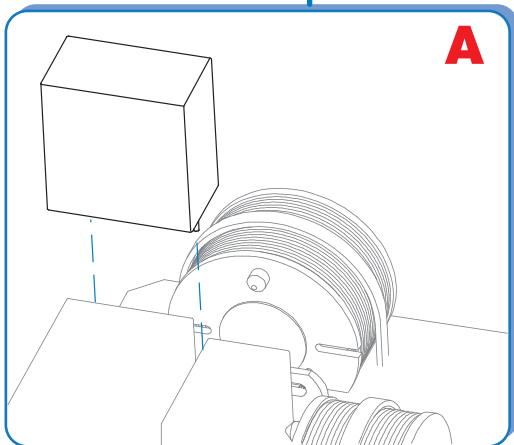
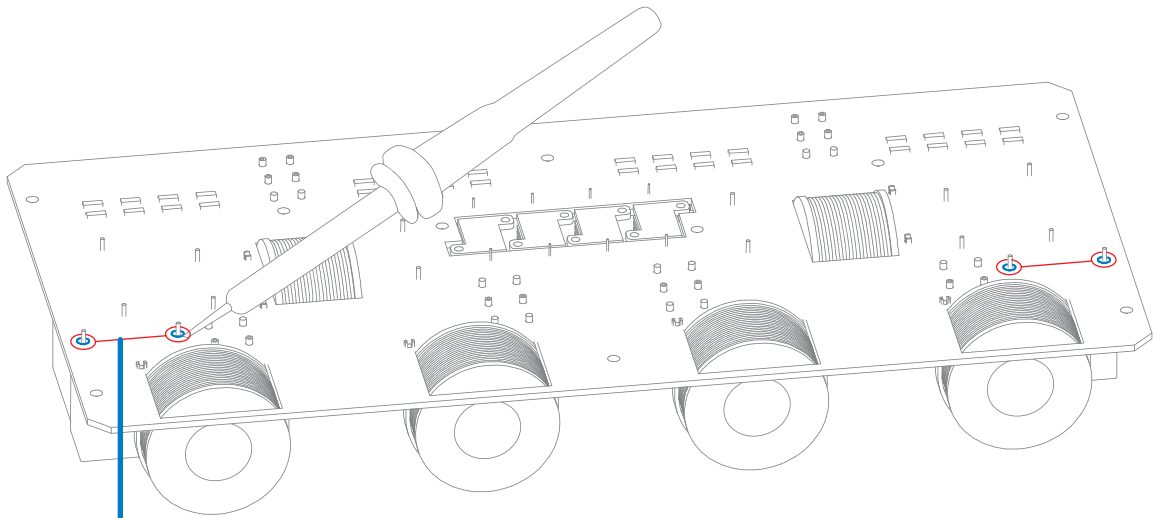

Insert the supplied 10  $\mu$ F capacitor

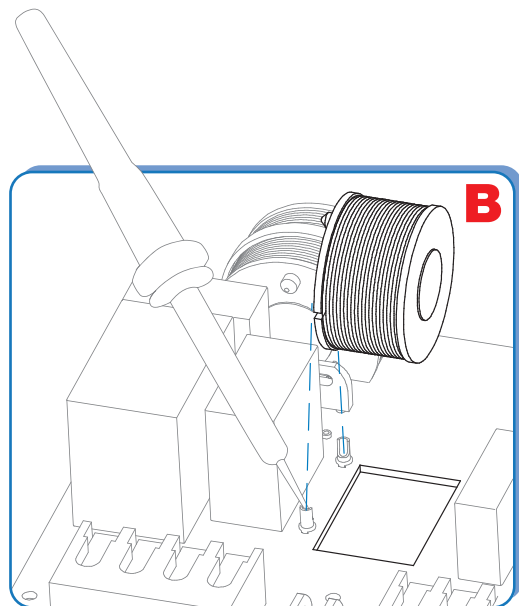

Insert the supplied 1,5 mH coil

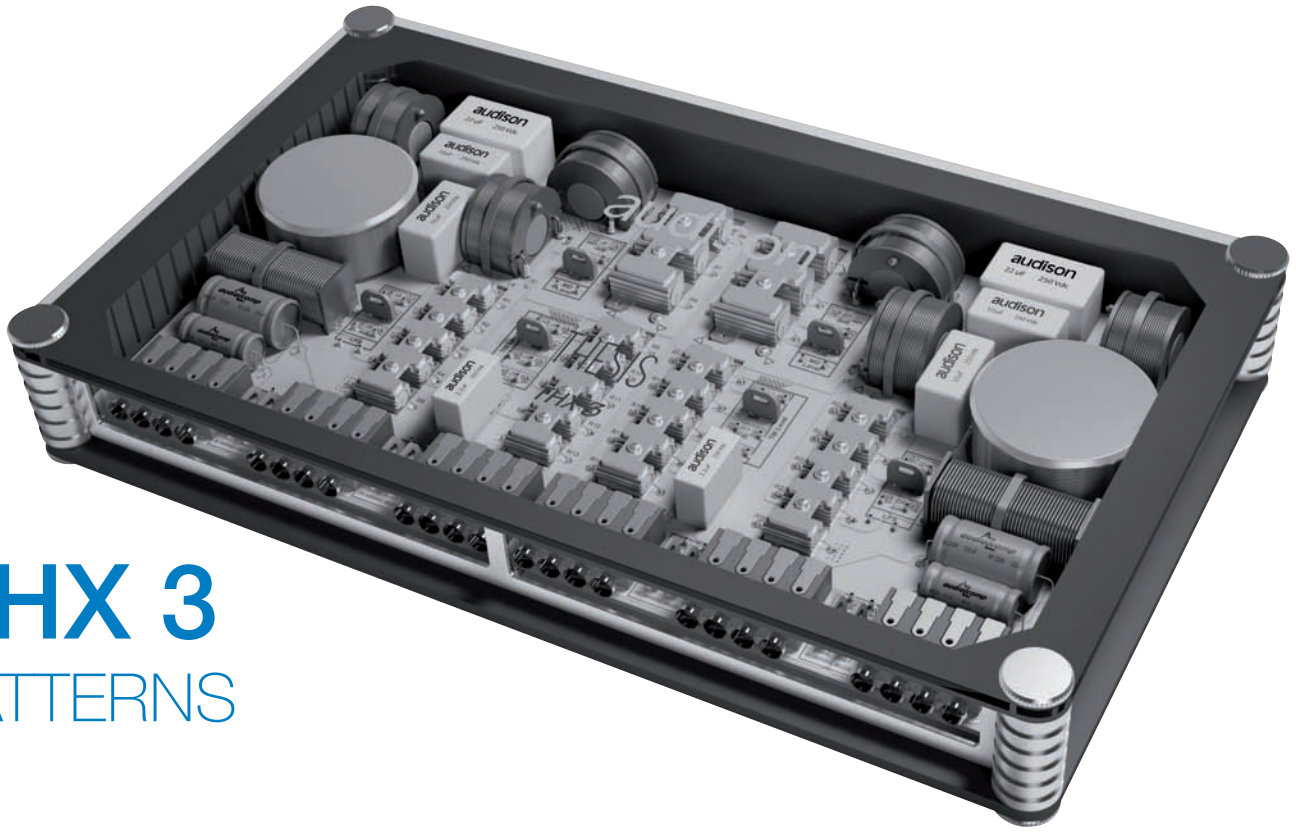

# THX 3

## PATTERNS

### TUNING KIT (supplied)

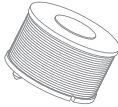
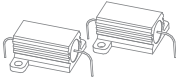
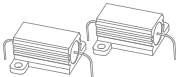
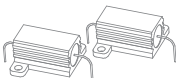
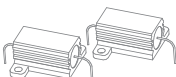
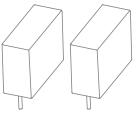
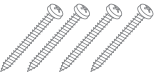
- N° 2 1.5 mH, Ø 42 mm inductances 
- N° 2 6,8Ω, 10W Resistors 
- N° 2 2,2Ω, 25W Resistors 
- N° 2 2,7Ω, 25W Resistors 
- N° 2 3,3Ω, 25W Resistors 
- N° 2 10μF, 250V Polypropylene capacitors 
- N° 4 4,2x38 mm cross headed, self-tapping fixing screws 



# THX 3 Mono-Wiring connection

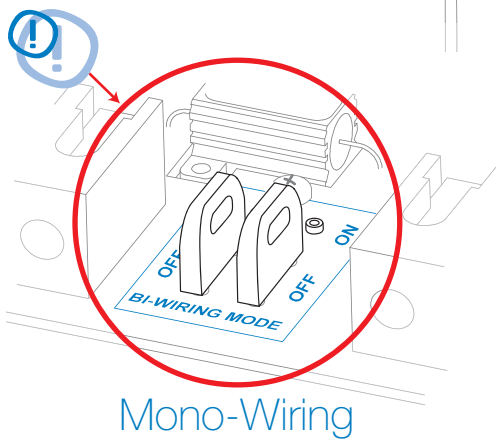
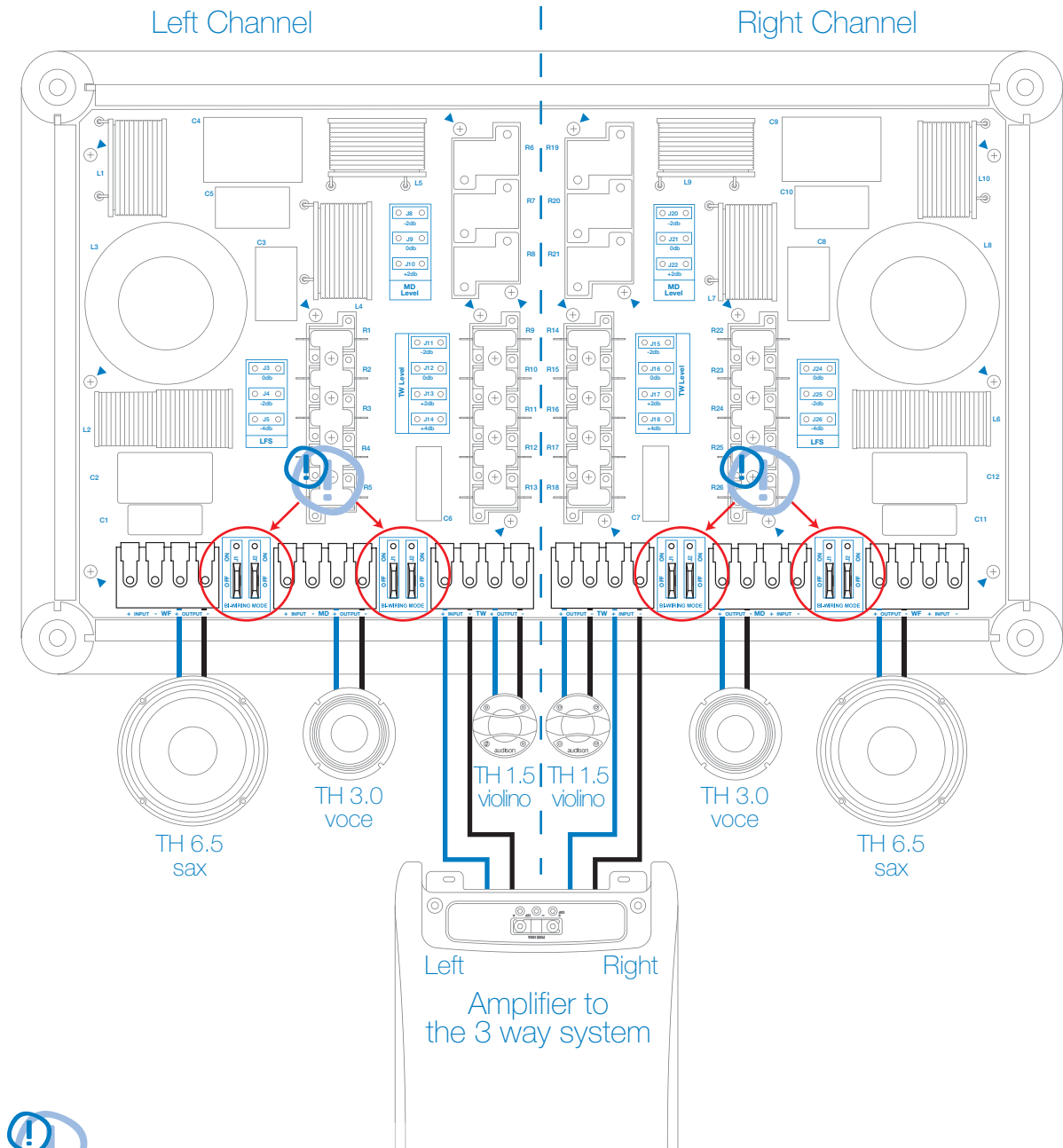

THX 3



# THX 3 Bi-Wiring connection

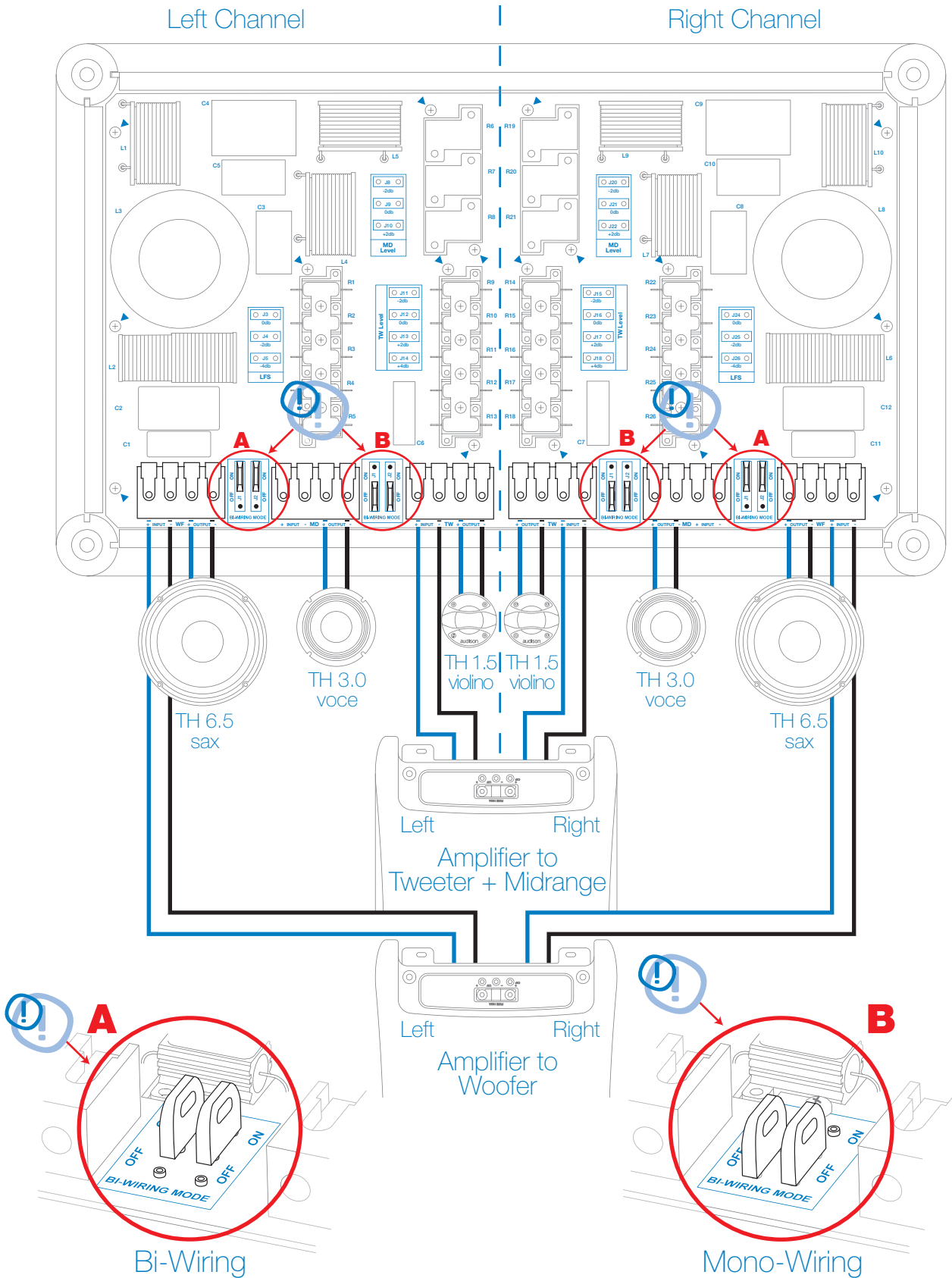

THX 3



# THX 3 Tri-Wiring connection

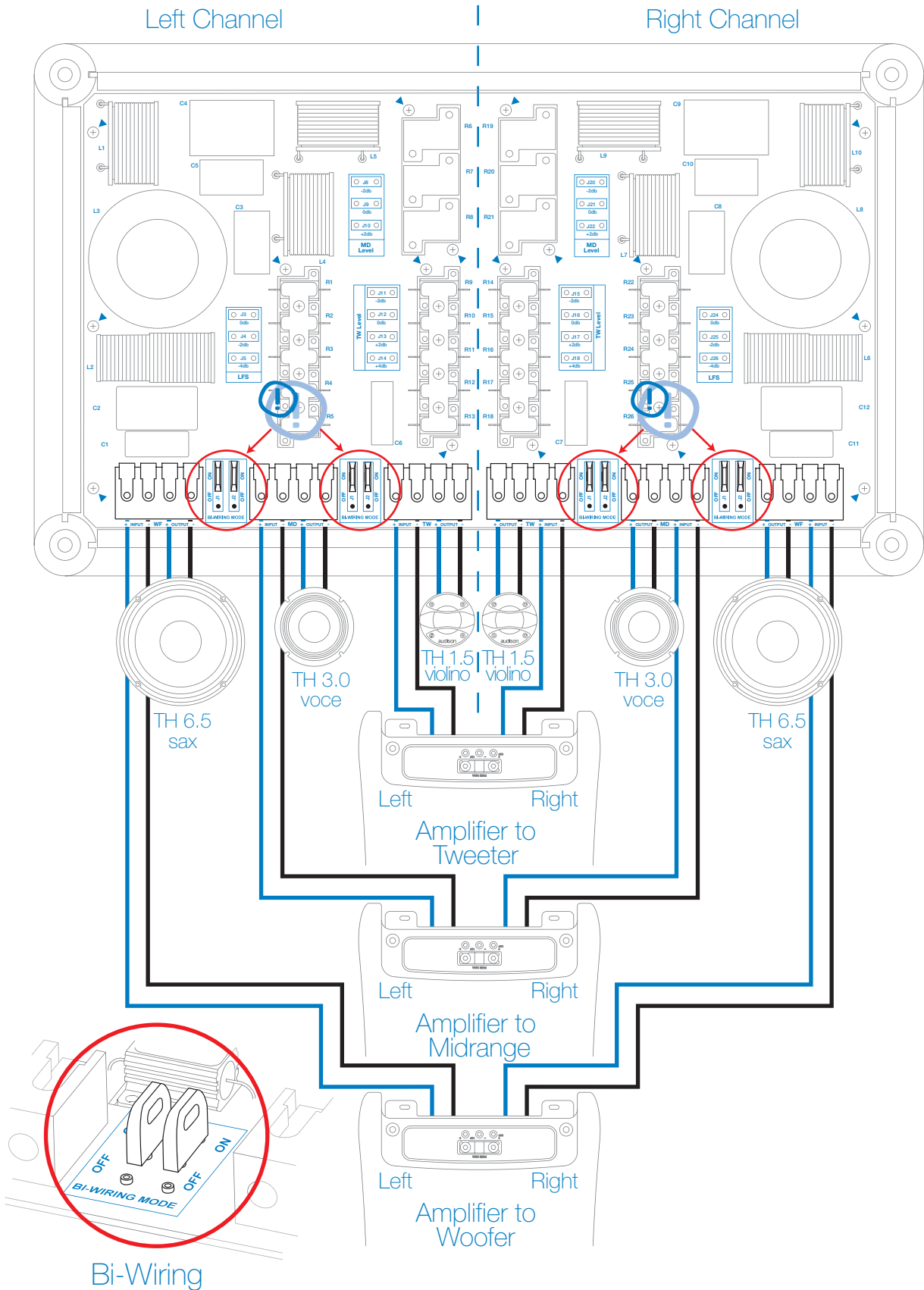

THX 3



# THX 3 Installation recommended with default set filter

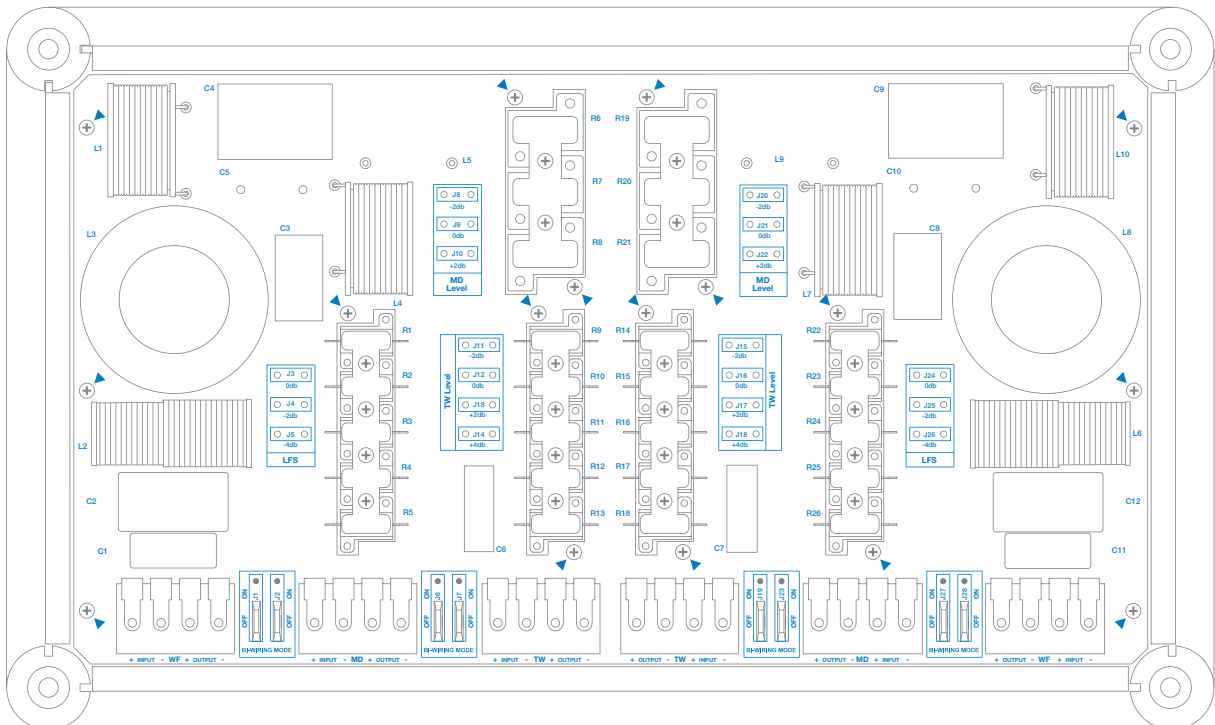
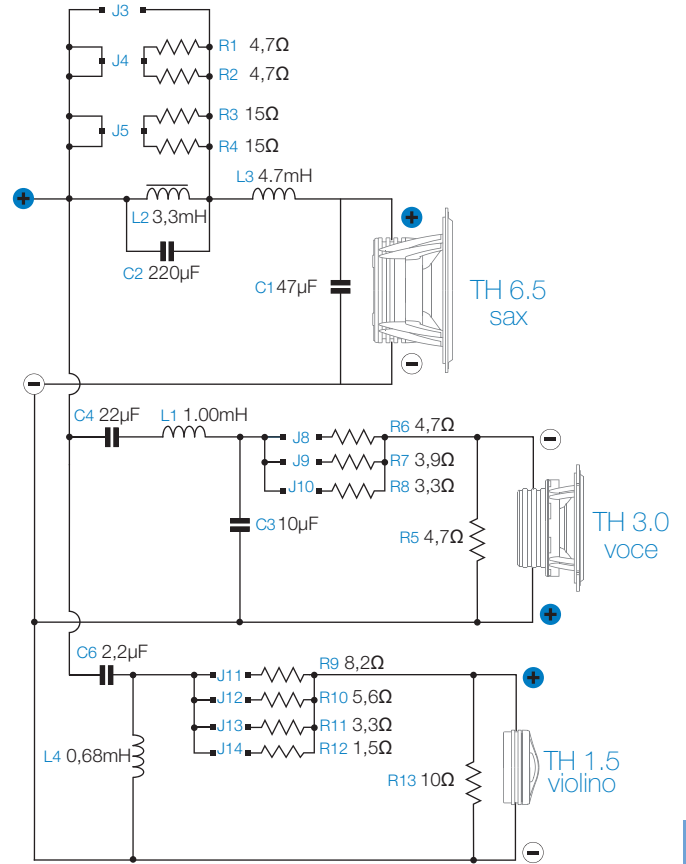
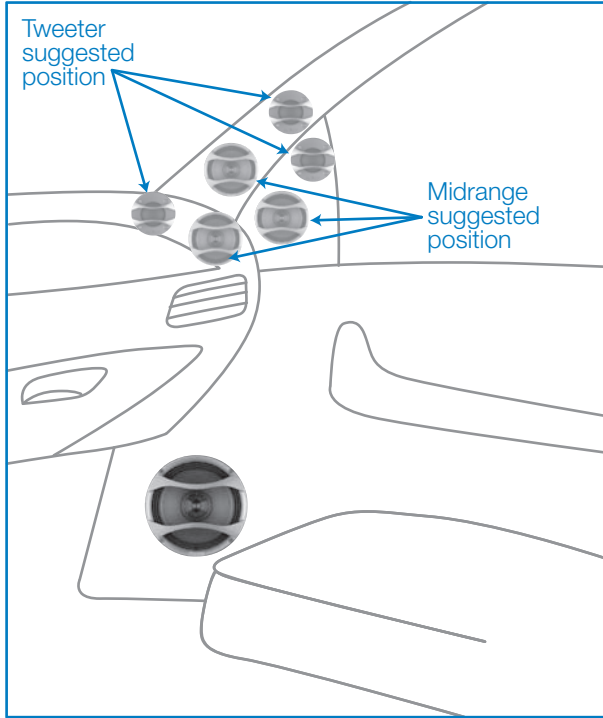

THX 3



# THX 3 Installation with door mounted midrange

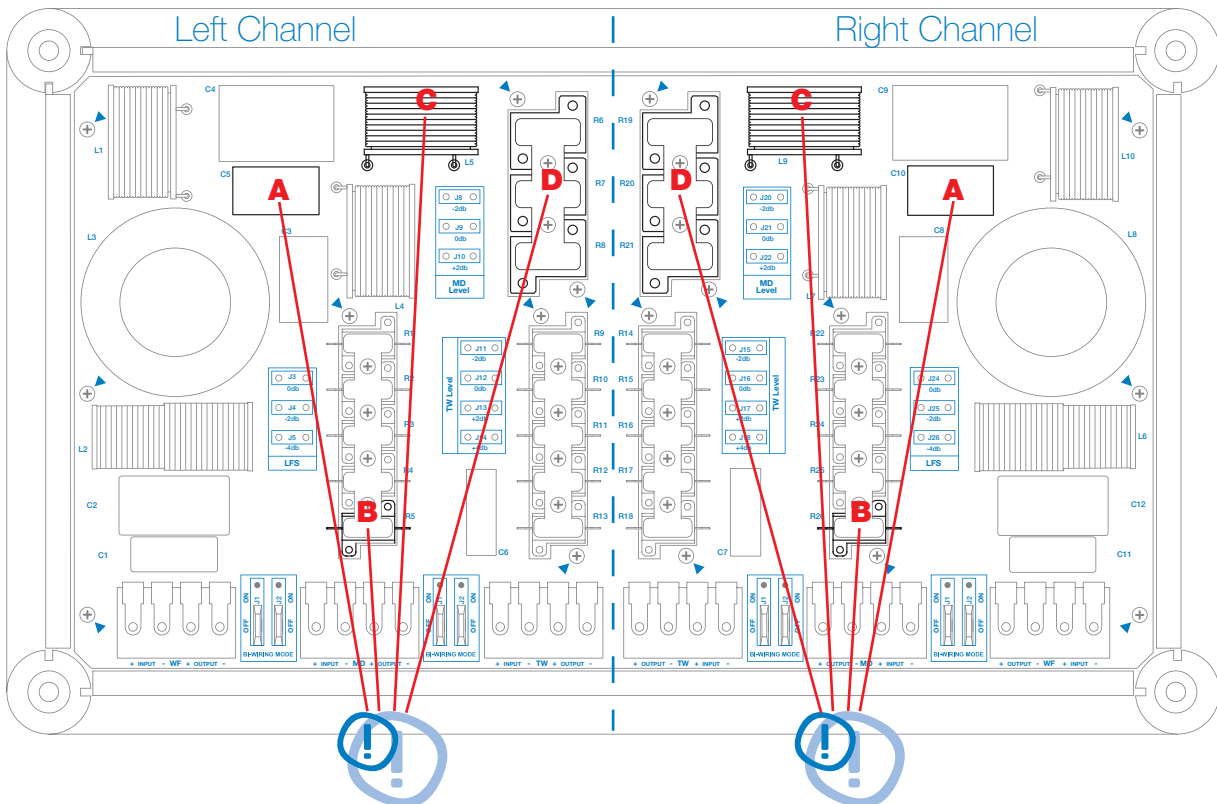
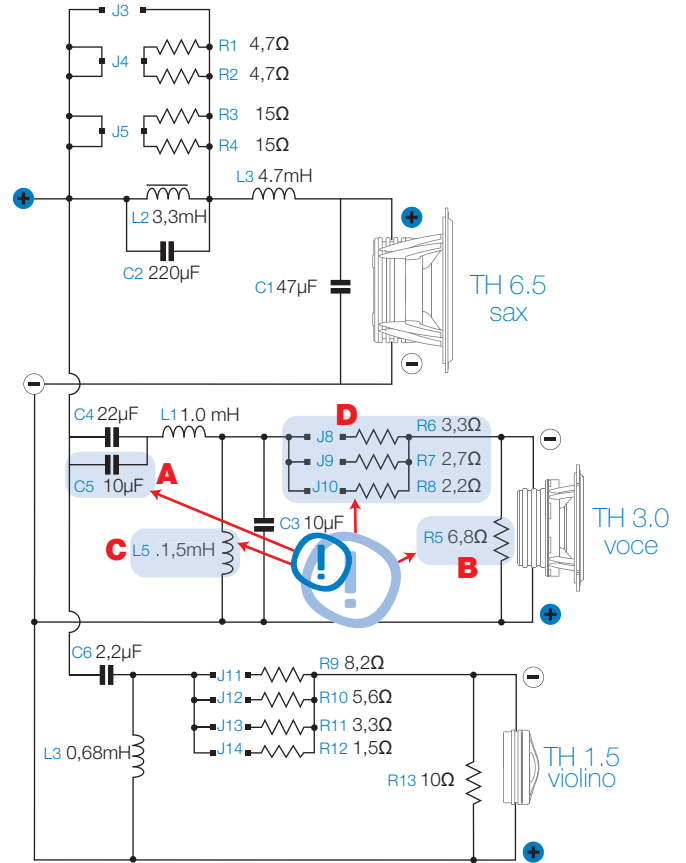
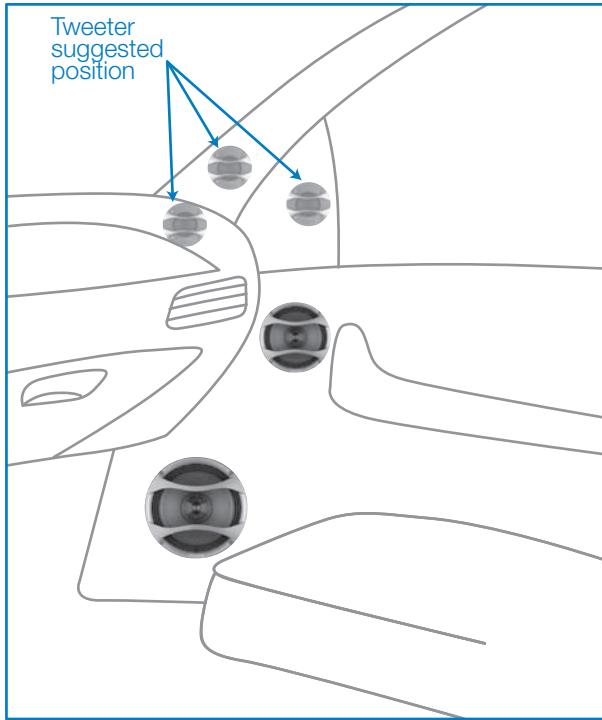

WORK ON THESE COMPONENTS! (see page 37÷39)



# THX 3 Installation with door mounted double woofer

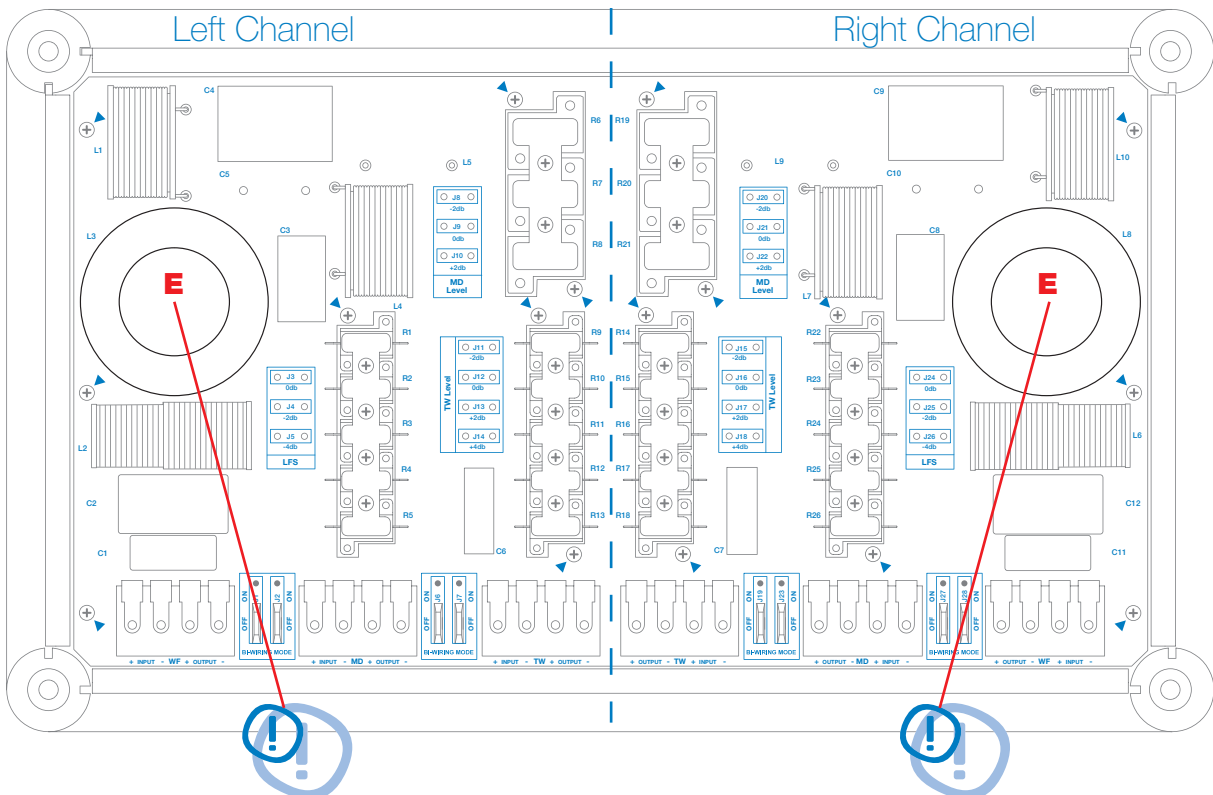
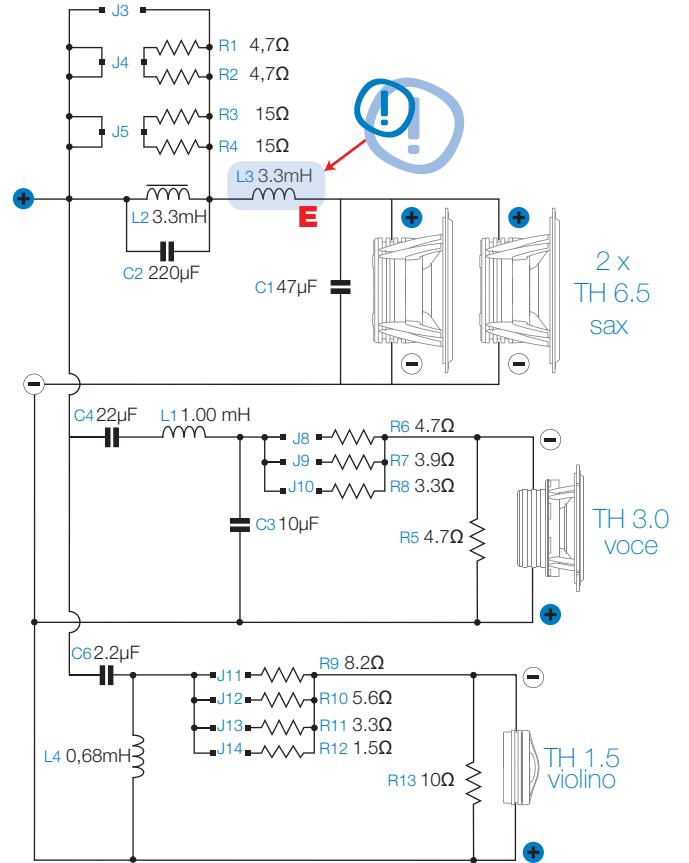
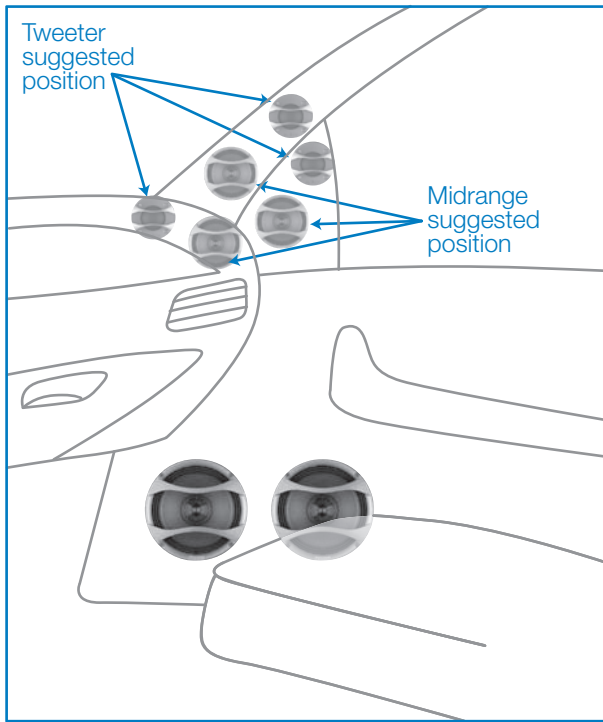

WORK ON THIS COMPONENT! (see page 37÷39)





# THX 3 Installation with door mounted double woofer and midrange

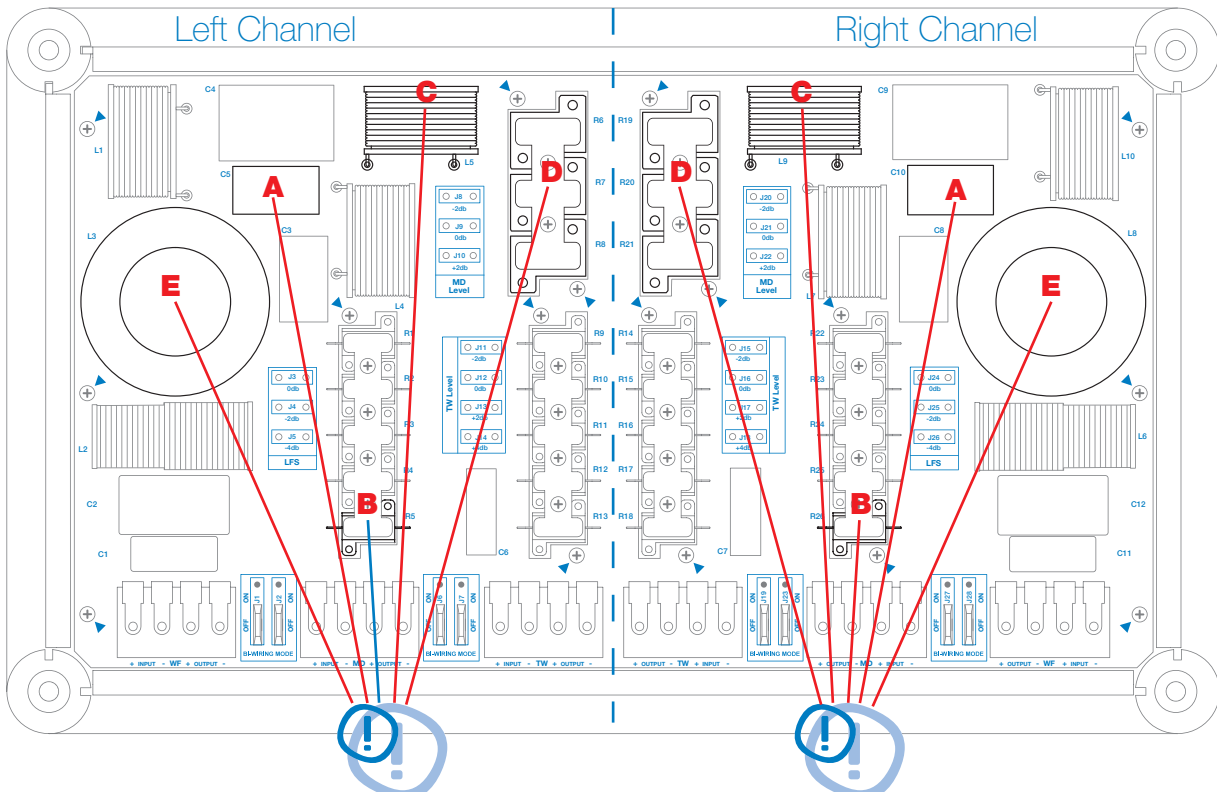
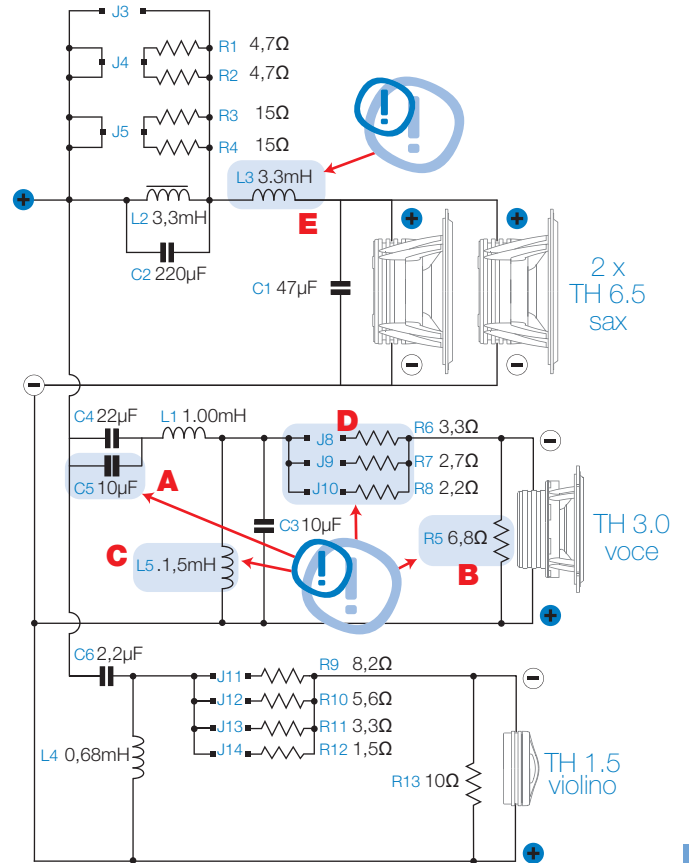
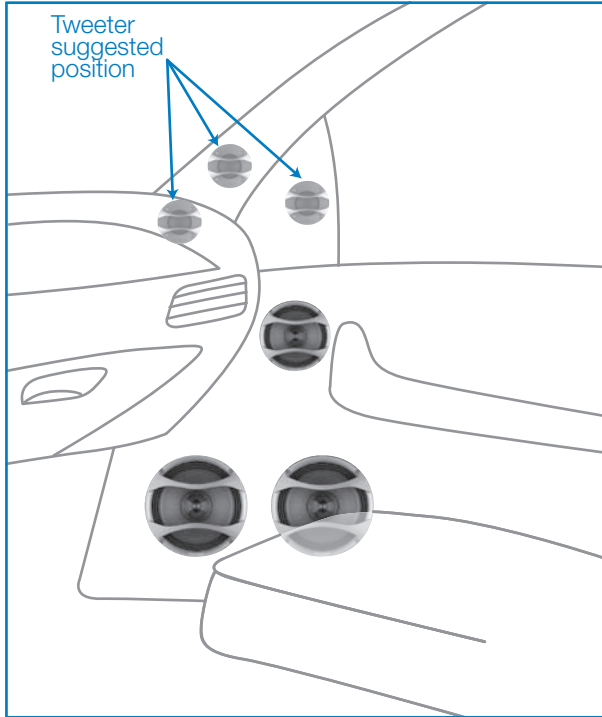

WORK ON THESE COMPONENTS! (see page 37÷39)



# THX 3 Tweeter Level Adjustment

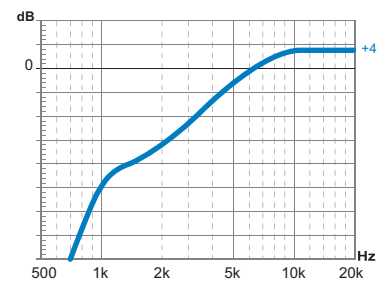
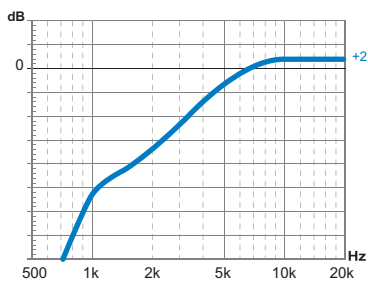
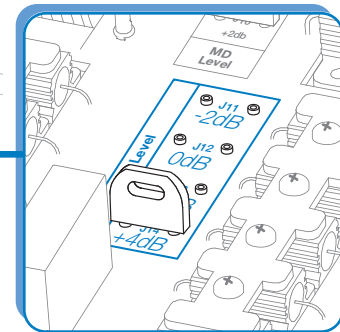
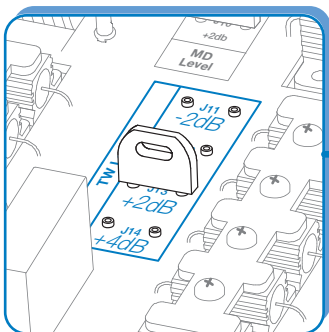
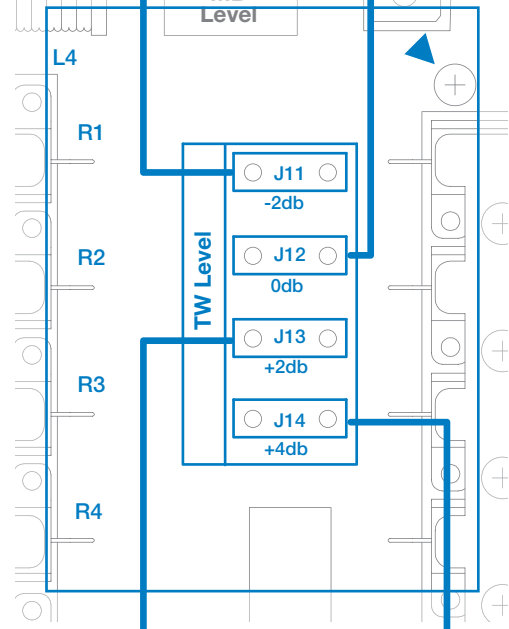
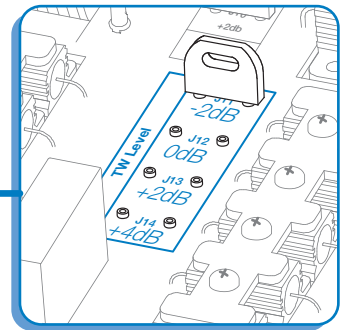
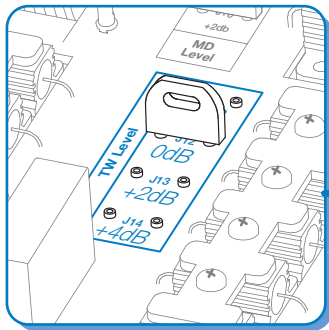
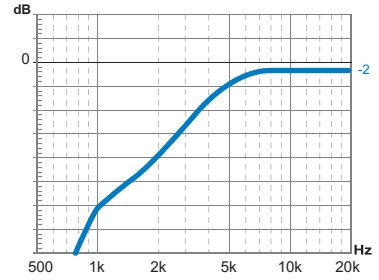
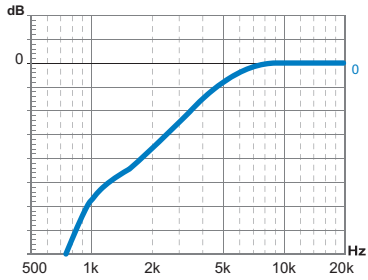

THX 3



# THX 3 Midrange Level Adjustment

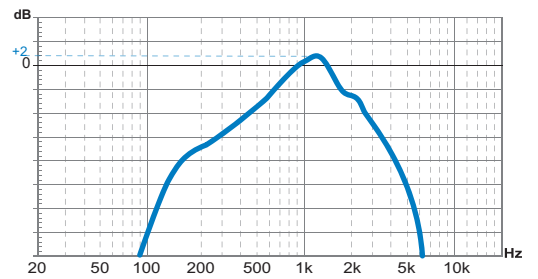
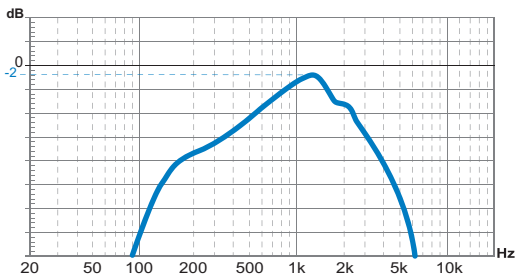
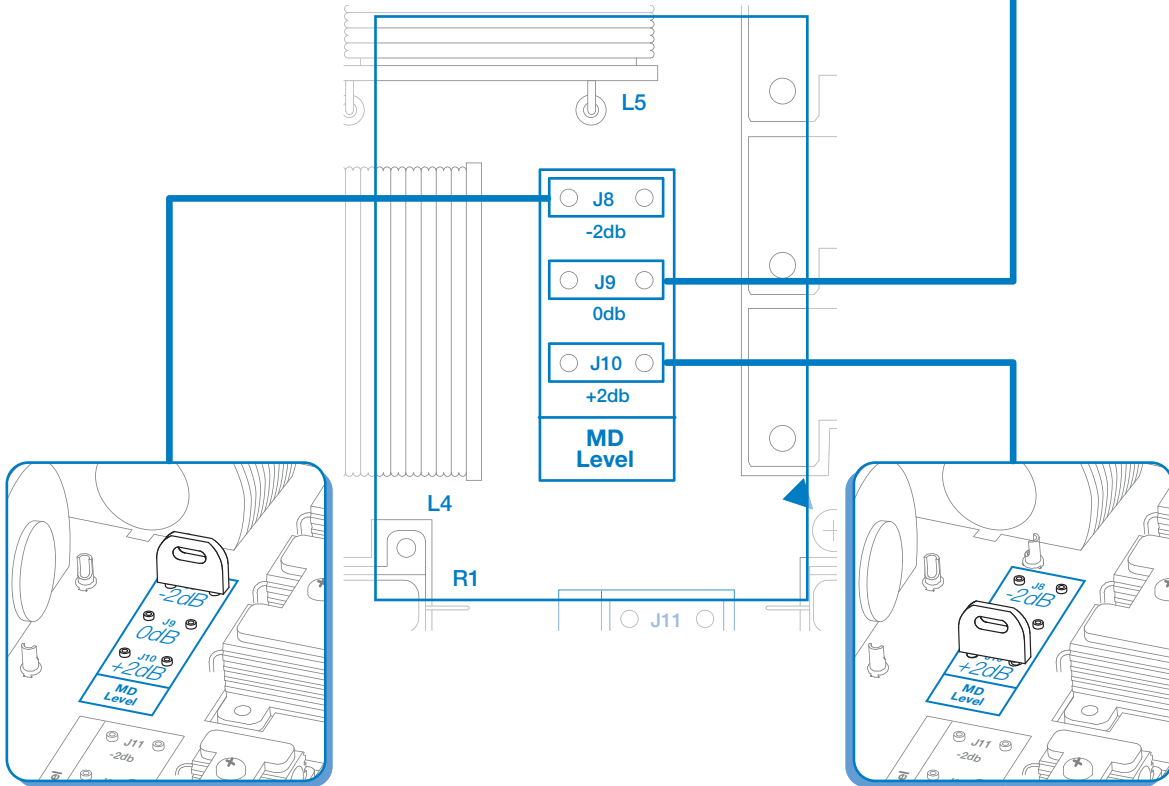
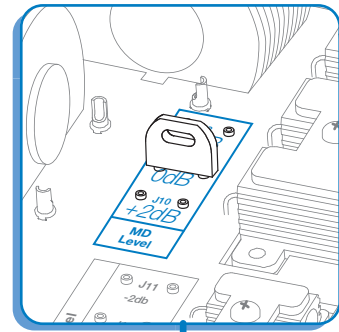
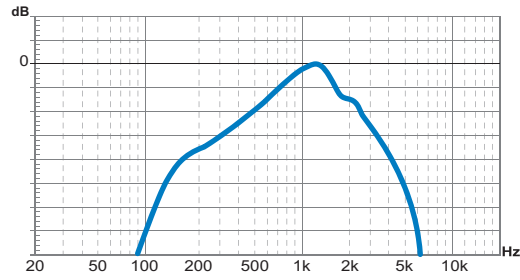

THX 3



# THX 3 LFS (Low Frequency Shaping)

Adjusting Low Frequency Response to eliminate resonances

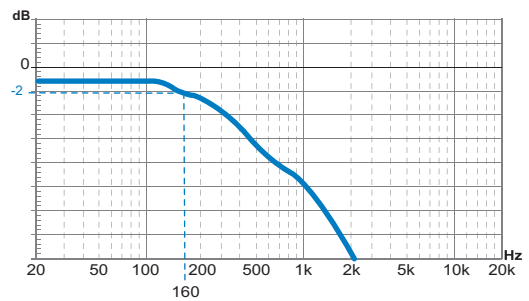
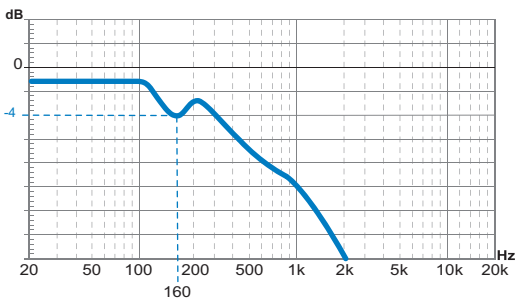
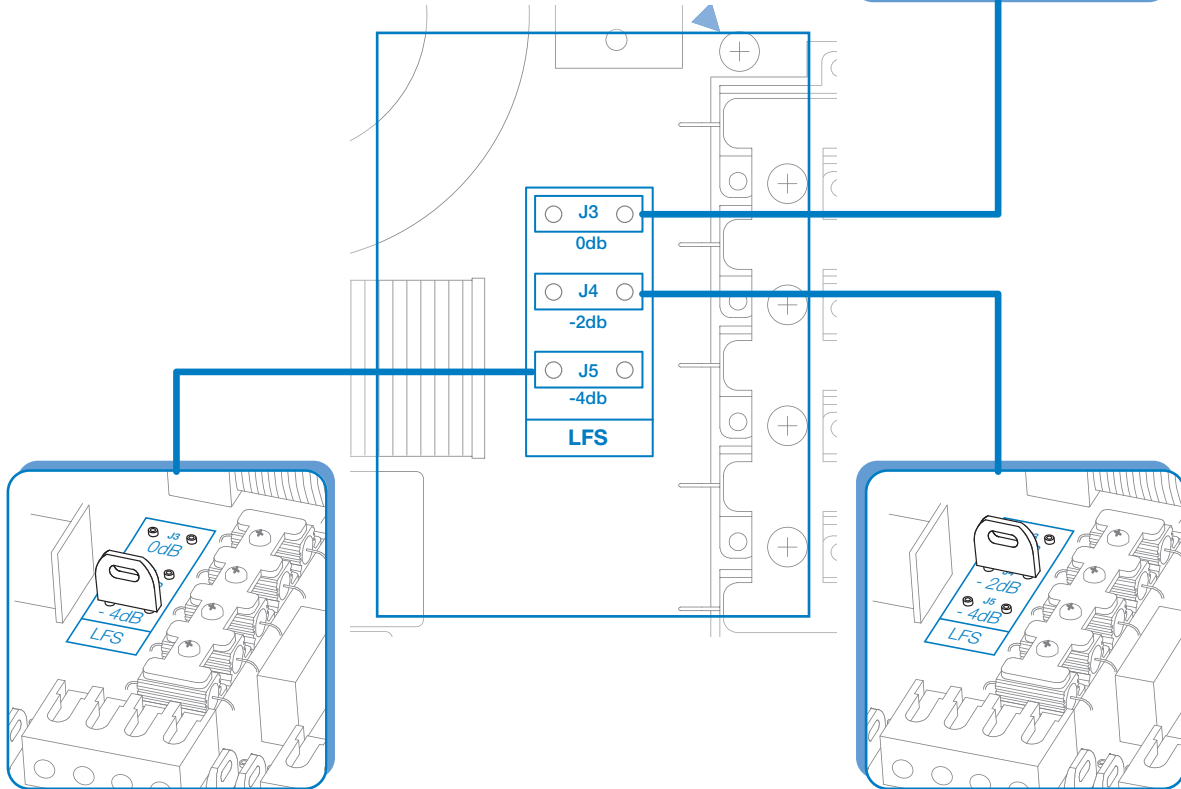
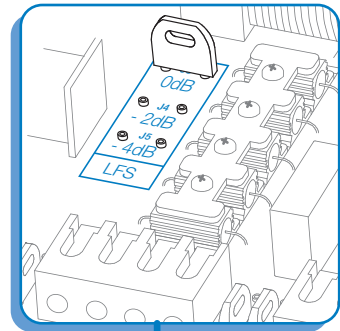
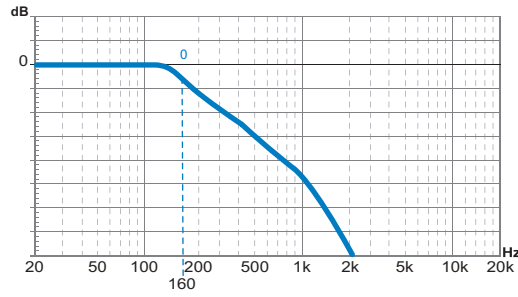

THX 3



# THX 3 How to disassemble the circuit board

Step 1: remove plexiglass cover (see page 4)

Step 2: remove the main screws (marked in blue)

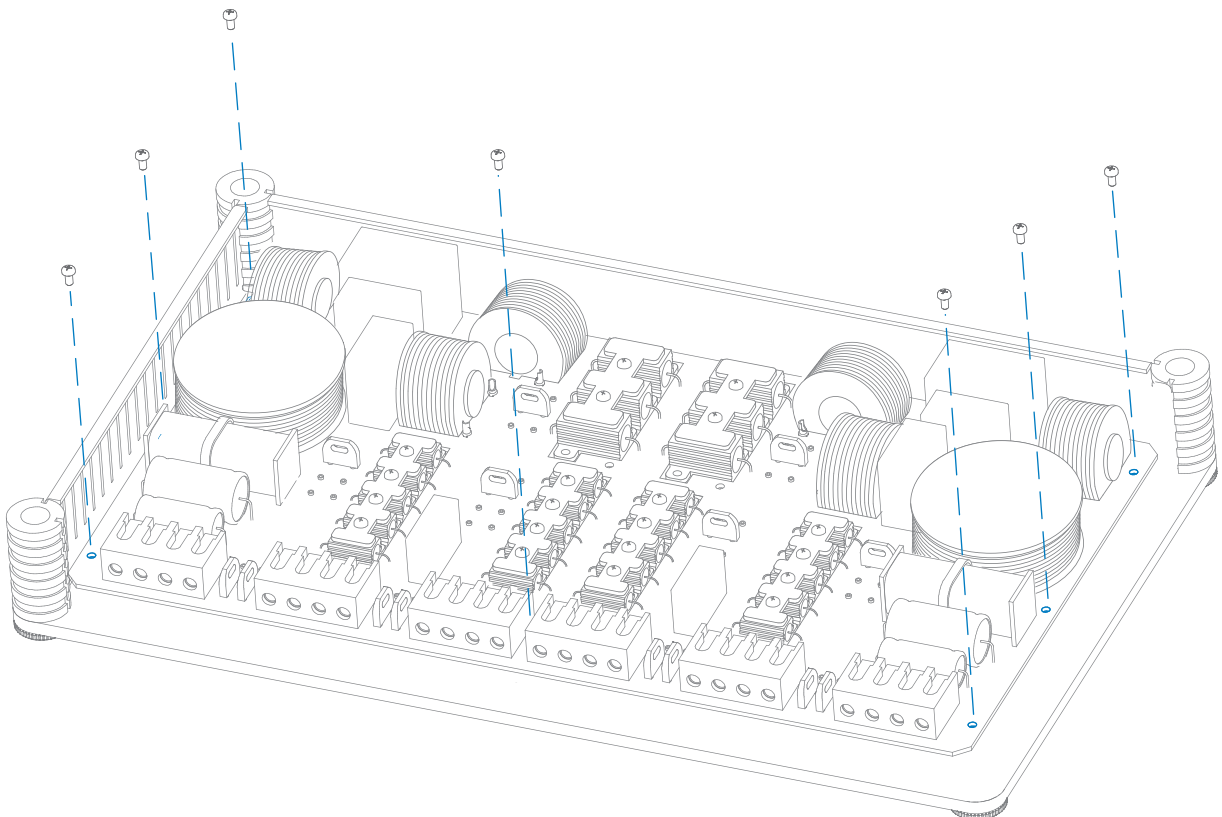
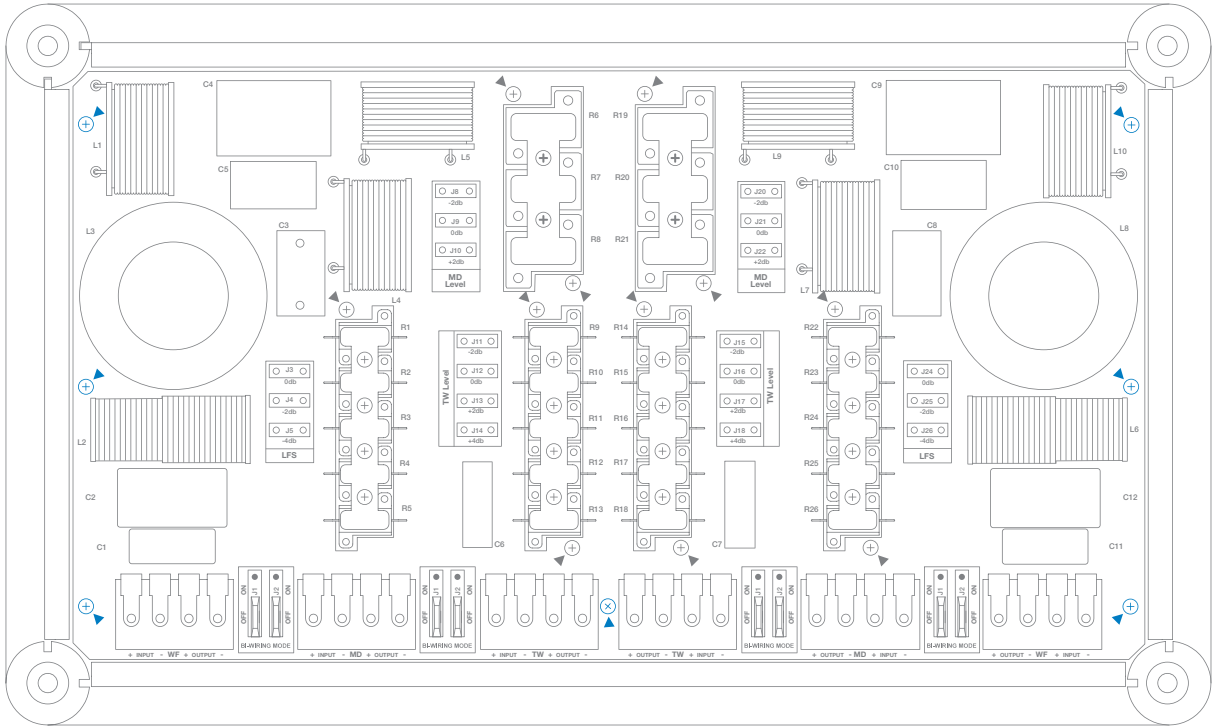

# THX 3 How to disassemble the circuit board

Step 3: remove the screws that secure the resistor blocks (marked in blue)

Step 4: remove the screws that secure the resistors with the clamps

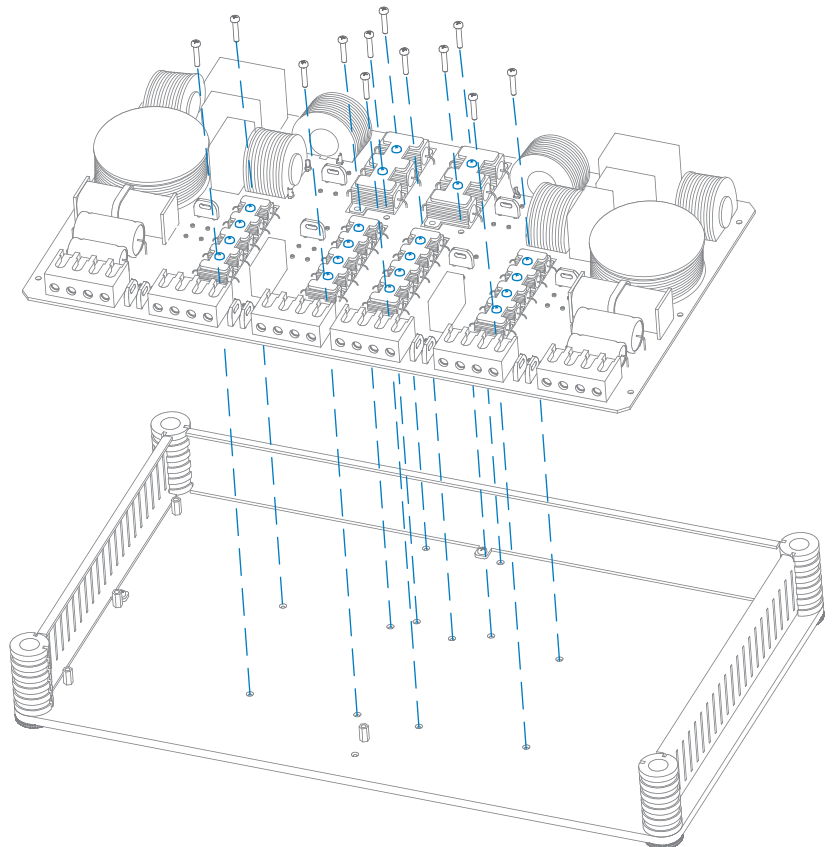
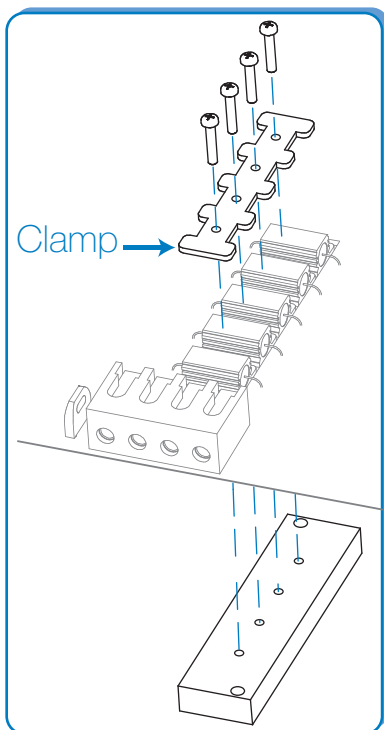
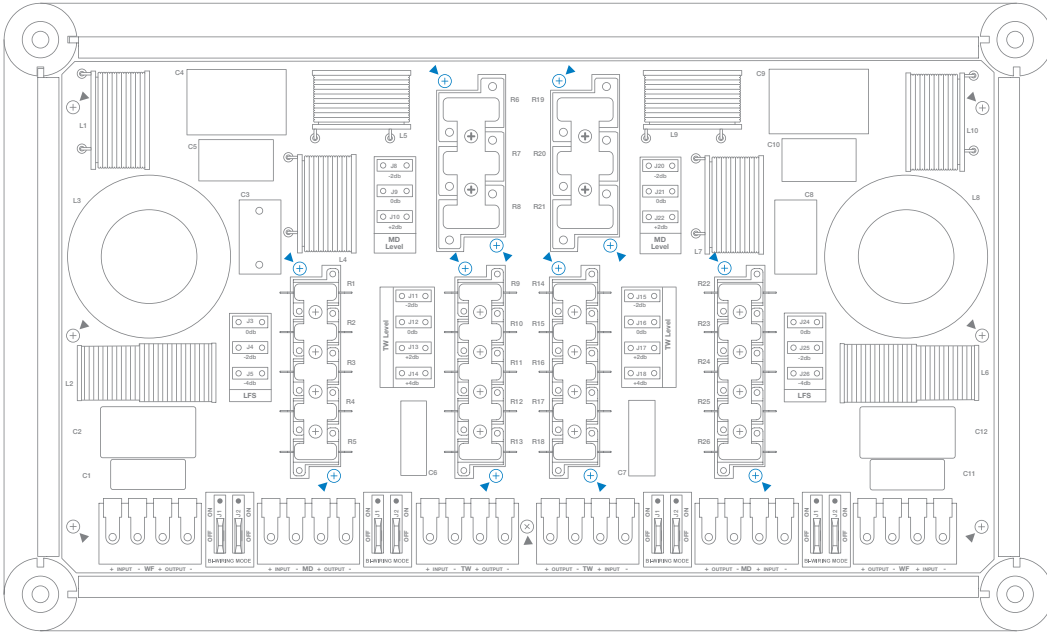

# THX 3 Modifications on the single components

1. Remove the screws securing the coil from the bottom of the PCB;
2. Unsolder the coil leads;
3. Unwind the coil with the help of an LCR meter until the value of 3,3 mH can be measured;
4. Refixe the coil.

Replace the 4,7Ω resistor originally mounted with the 6,8Ω one, supplied with the product.

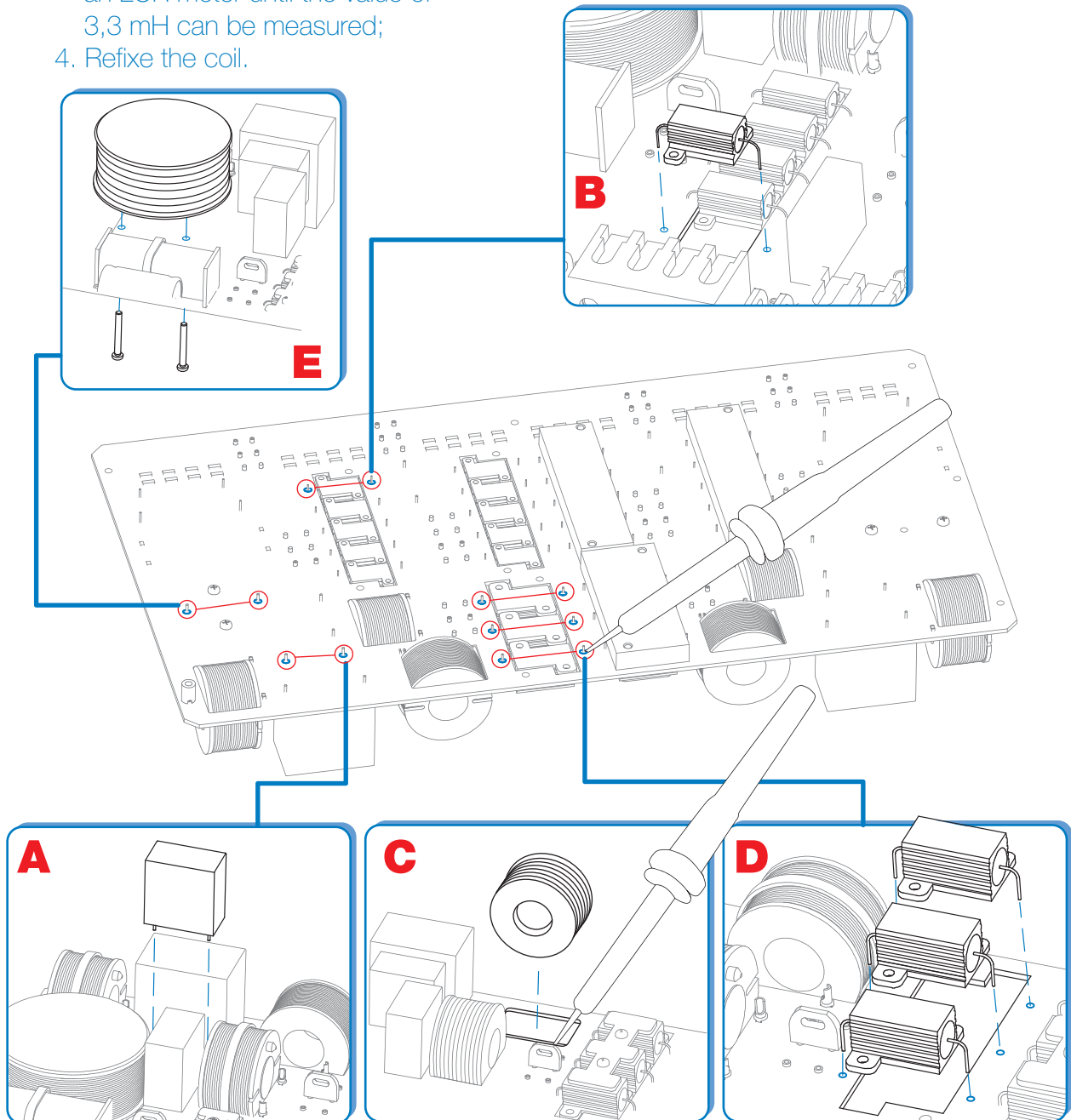

Insert the supplied 10 μF capacitor

Insert the supplied 1,5 mH coil

Replace the supplied resistors originally mounted following the diagram on page 31 or 33



# Technical Specifications

		THX 2	THX 3	THX mh
<b>Type</b>		Stereo 2 way Passive Crossover Network	Stereo 3 way Passive Crossover Network	Stereo 2 way Mid-High Passive Crossover Network
<b>Size</b>	mm / inch	348x190x66,5 13 <sup>3/4</sup> x7 <sup>1/2</sup> x2 <sup>5/8</sup>	438x258x66,5 17 <sup>1/4</sup> x10 <sup>1/4</sup> x2 <sup>5/8</sup>	348x190x66,5 13 <sup>3/4</sup> x7 <sup>1/2</sup> x2 <sup>5/8</sup>
<b>Power</b>	W peak	400	400	400
<b>Handling</b>	W continuous	200	200	200
<b>Crossover frequency</b>	LO/Hi-pass	2.5 kHz	450 Hz / 3.5 kHz	280 Hz / 3.5 kHz
<b>Slope</b>	dB/Oct.	6/12	12/6-12/12	6 (ON-OFF) / 12 (default) 12 (ON-OFF) / 12 (optional)
<b>Thesis speaker set</b>		TH 1.5 violino + TH 6.5 sax	TH 1.5 violino + TH 3.0 voce + TH 6.5 sax	TH 1.5 violino + TH 3.0 voce
<b>Component Adjustment</b>	Tweeter Midrange	-2; 0; +2; +4 dB	-2; 0; +2; +4 dB -2; 0; +2 dB	-2; 0; +2 dB MD Hi-pass ON/OFF (280 Hz @ 6/12 dB/Oct.)
	Woofer	LFS 0; -2; -4 dB	LFS 0; -2; -4 dB	
<b>Sound Control</b>		Low Frequency Shaping Speaker Position Contour Multi-Amp Configuration Audison Thesis Advisor	Low Frequency Shaping Speaker Position Contour Multi-Amp Configuration Audison Thesis Advisor	Low Frequency Shaping Speaker Position Contour Multi-Amp Configuration Audison Thesis Advisor